



www.saftronics.com

PROFIBUS-DP OPTION CARD

SOPC-G11S-PDP

FOR GP10 & VG10

INSTRUCTION MANUAL

Saftronics, Inc.

5580 Enterprise Pkwy., Ft. Myers, FL 33905

Telephone: (239) 693-7200

Fax: (239) 693-2431

www.saftronics.com

PART NUMBER 027-2157

REV July 2002

Revision Notes

Date:	Document:	Notes:
00.01.24	Revision 1.00	Created
00.01.30	Revision 1.01	8.4 Monitoring data, data format correction
00.08.03	Revision 1.02	Extended System configuration chapter 10
02.04.24	Revision 1.03	Updated chapter 1 and 7.6

Preface

The data and illustrations found in this document are not binding. We reserve the right to modify our products in line with our policy of continuous product development. The information in this appendix is subject to change without notice and should not be considered as a commitment by HMS INDUSTRIAL NETWORKS AB.

HMS INDUSTRIAL NETWORKS AB assumes no responsibility for any errors that may appear in this document.

The product and technology described in this document is patent pending in the following countries:

USA, Canada, Japan, Belgium, Denmark, Finland, France, Greece, Ireland, Italy, Luxemburg, Monaco, Netherlands, Portugal, Switzerland, Lichtenstein, Spain, United Kingdom, Sweden, Germany and Austria.

ANYBUS® is a registered trademark of HMS INDUSTRIAL NETWORKS AB.

All other trademarks are the property of their respective holders.

Related documents

Document	Author
PROFIBUS Profile for variable speed drives, PROFIDRIVE. PNO Order-No 3.072	PROFIDRIVE working group of Profibus Nutzerorganisation
GP10 Instruction Manual P/N 027-GP1001 VG10 Instruction Manual P/N 027-VG1001	Saftronics

Table of Contents

1. Applicable inverters.....	5
2. Receiving Inspection.....	6
3. Installation	7
3.1 Installation Method	7
3.2 Installation Checklist	8
4. Profibus option card SOPC-G11S-PDP.....	9
5. Introduction to Profibus-DP	9
5.1 Technical features of Profibus-DP	9
6. SOPC-G11S-PDP Overview	11
6.1 Physical interface.....	11
6.2 Configuration.....	12
6.2.1 Baudrate	12
6.2.2 Termination	12
6.2.3 Node Address.....	12
6.2.4 PPO-type selection	13
6.2.5 Changeover of communications	14
6.2.5.1 Changeover method for communication control	14
6.2.5.2 Link function configuration (operation selection).....	15
6.2.5.3 Coexistence of link (option) and RS485 (or Modbus RTU) communication	15
6.2.6 Fast stop	15
6.2.7 Configuration of PCD word 1-4.....	16
6.3 Action at communication error.....	17
6.4 Indication LED's.....	20
7. Operating the drive via Profidrive profile.....	21
7.1 PPO- description.....	21
7.2 PCD-part.....	22
7.2.1 Control- / status word.....	22
7.2.2 Frequency setpoint/ Actual frequency	27
7.2.3 PCD word 1-4	27
7.3 PCV-part.....	27

7.4	Example	30
7.5	Profidrive specific parameters	31
7.6	Malfunction codes.....	33
8.	Parameters specific for communication.....	35
8.1	Command data.....	35
8.2	Operation command data	35
8.3	Function data	37
8.4	Monitoring data.....	38
9.	Parameter data format.....	40
9.1	List of parameter data format	40
9.2	Data format specification	46
10.	System configuration	51
10.1	Hardware configuration	51
10.2	Software configuration	54
11.	GSD-file	56

1. Applicable inverters

Item	Description		
Inverter type	GP10 / VG10		
Compatible Inverter Model number (Saftronics version)	The last two digits of the model number should be B1 or later Example: 6KG1123X1B1		
Minimum inverter ROM version number	up to 22 kW(30HP)	EN, Japanese Standard, JE, CN, UX and Saftronics version	S08000 and after (It is impossible to use version prior to S08000 inverter.)
	30 kW(40HP) and above	EN, Japanese standard, JN, JE, AN, CN, UX and Saftronics version	H08004 and after (It is impossible to use versions of H00000 to H08003.)

NOTE:

This product can only be used for Inverters with ROM version numbers greater than or equal to the versions shown above.

And in the case of installing this option in the GP10 / VG10 inverter that is a Japanese standard, JN, JE or CN version, please contact Saftronics or its distributors.

Check the ROM number of your Inverter as follows using the inverter keypad.

- a. Check that the Inverter Operation monitor (Operation mode) screen is displayed.
- b. Press the [PRG] key of the Inverter once.
- c. Select the "5. MAINTENANC" with the cursor and press the [FUNC/DATA] key.
- d. Press the down cursor key to increment the display at the MAINTENANC screen.

Finally, the ROM number is shown in the maintenance information, as indicated by the display "INV=Hxxxxx or Sxxxxx".

The maintenance and inspection items are similar to the Inverter unit, for detail refer to the Inverter Instruction Manual.

2. Receiving Inspection

Confirm the following items upon a receipt.

- 1) The model number matches your purchase order?
Check the model number printed on the circuit board.

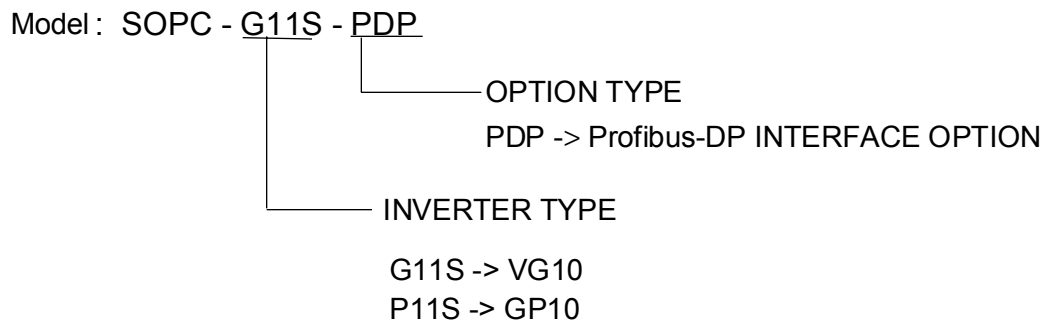

- 2) Inspection for damage during transportation. Report damage to transportation carrier.

3. Installation

3.1 Installation Method

Please follow the installation procedure described as follows. Please install or detach the option after turning off the input power supply of the inverter and confirming the charge lamp (CHARGE or CRG) is gone out.

The shape, the dimensions and the position of the charge lamp of the inverter are different by each capacity.

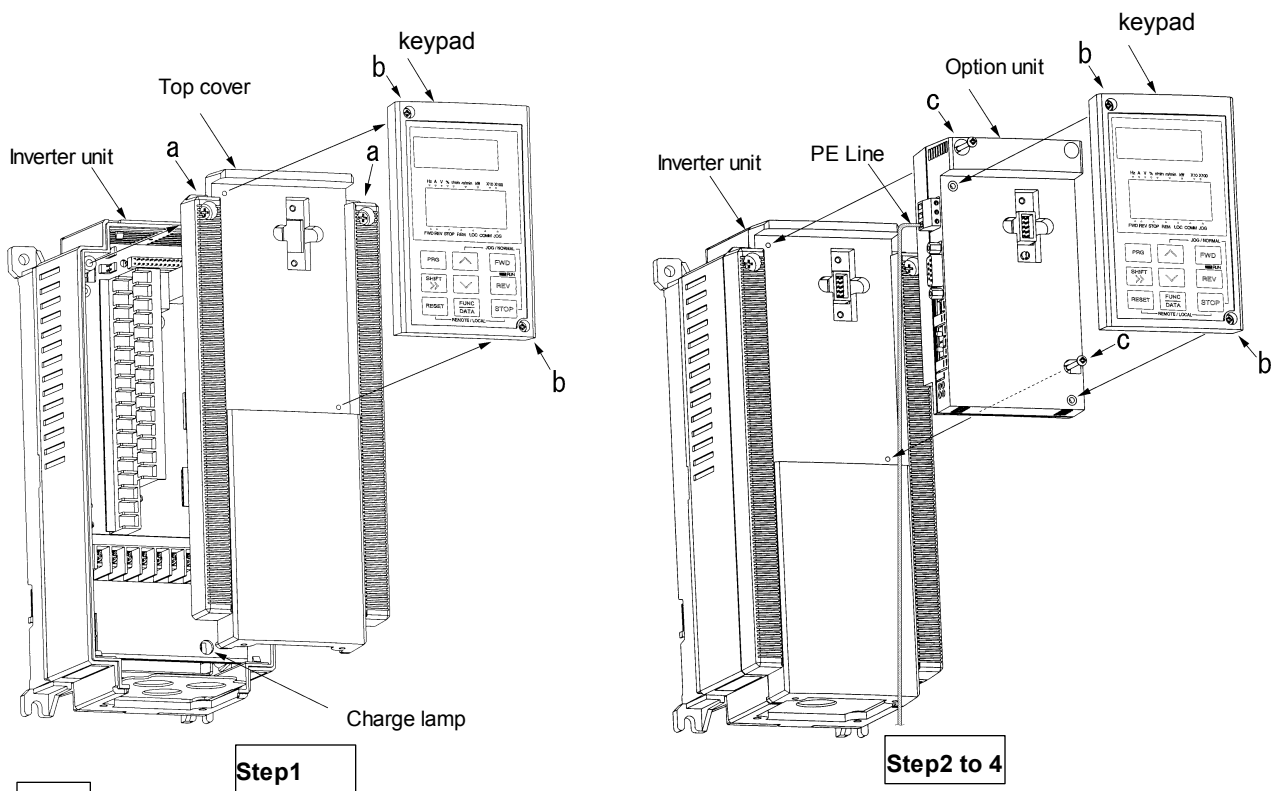

Step1

Loosen two screws(M4) at **a** and remove the top cover. Loosen two screws(M3) at **b** and detach the keypad panel. (For the 30kW[40HP] and above inverters, the keypad panel can be detached if the front cover is removed and the screws loosened at **b**.)

Step2

Reassemble the top cover, push-in the option unit and secure it with two screws(M3) at **c**.

Step3

Secure the keypad panel to the option unit with two screws at **b**.

Step4

Connect the ground cable to the PE terminal of the option unit.

3.2 Installation Checklist

After installation and wiring, check the following items.

- [1] The wiring is correct.
- [2] No loose wires or screws remain inside the Inverter.
- [3] The screws and terminals are all tight.
- [4] There are no loose threads of wires at terminals that may contact other terminals.
- [5] The switch positions on the Anybus-S module, JP6 on the conversion-board are suitable for the use purpose.
(Do not change the JP4 on the conversion-board !)
- [6] Inverter parameters such as H30, E15, E30 to E32, o27, o28, o30 to o38, are set correctly. (H30: Link Active/Inactive, E15: effect to OFF3, E30: effect to Bit 8 of Status word, E31 and E32: effect to Bit 10 of Status word, o27 and o28: for RAS, o30: PPO type, o31 to o38: PCD setting)

4. Profibus option card SOPC-G11S-PDP

The SOPC-G11S-PDP option card gives an instant connection between Safronics GP10 / VG10 drives and Profibus-DP. The option board will perform as an integrated part of the GP10 / VG10 drive and gives the user access to all relevant parameters, as well as control-/status signals needed to control the drive

The SOPC-G11S-PDP option card communicates according to the Profibus Protocol Standard DIN 19245 part 1 & 3. This means that it can communicate with all masters that comply with this standard, but it does not necessarily mean that all services available in the Profibus standard are supported. The VDI/VDE 3689 Profibus Profile for Variable Speed Drives, also known as Profidrive, is a subset of Profibus which only supports the services relevant to speed control applications.

In a control system the SOPC-G11S-PDP will act as a slave that can be read and written to, from a Profibus-DP master. It will not initiate communication to other nodes, it will only respond to incoming telegrams.

5. Introduction to Profibus-DP

Profibus has an international user organisation called Profibus International, PI, and local national organisations, PNO. HMS is represented as board member of Profibus Sweden since the start of the organisation in 1992 and also as member of the Technical Committee at the American Profibus Trade Organization, PTO.

Technical questions regarding the fieldbus should be addressed to your local Profibus User Group in the first instance. Address list is available on the Profibus Internet site; www.Profibus.com. For general help on Profibus, contact Profibus International on e-mail; Profibus_international@compuserve.com.

Profibus-DP is normally used in industrial automation, to transfer fast data for motor controllers, MMI, I/O units and other industrial equipment.

5.1 Technical features of Profibus-DP

- Physical media: EIA RS 485 twisted pair cable or fiber optic.
- Baud rate: 9.6 kbaud up to 12Mbaud.
- Maximum number of nodes: 126
- Maximum number of I/O: 244 bytes/slave.
- Bus topology: Master-Slave communication. The figure below gives an overview of a Profibus-DP network.
- Cyclic user data transfer between DP-Master and DP-Slaves.
- Watch-Dog Timer at the DP-Slaves
- Connecting or disconnecting stations without affecting other stations.
- Powerful diagnosis mechanisms, 3 hierarchical levels of the diagnosis messages.
- Synchronization of inputs and/or outputs.
- All messages are transmitted with Hamming Distance HD=4.

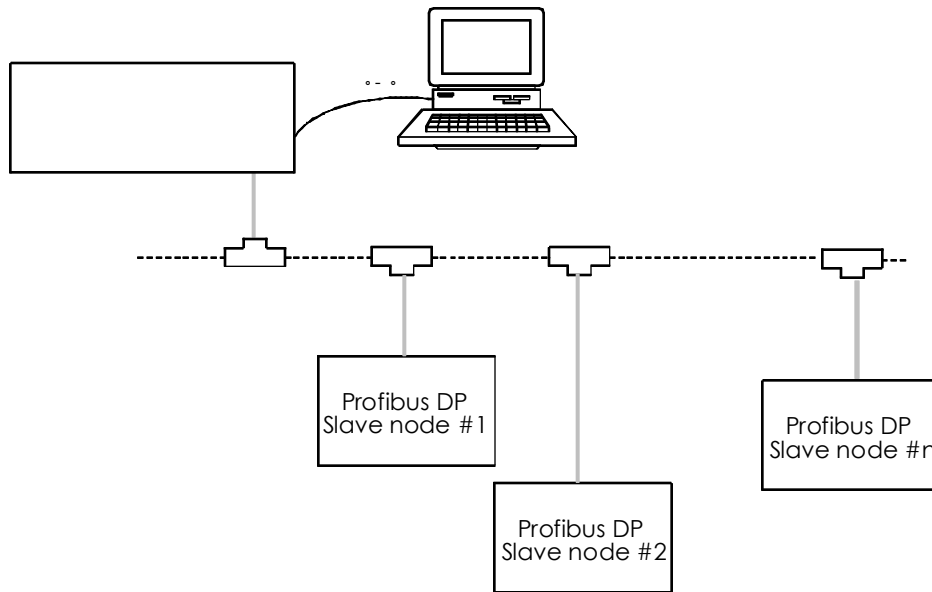

Figure 1 Bus topology of Profibus-DP

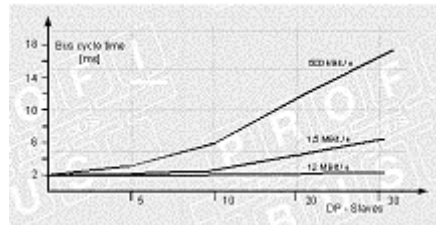

Figure 2 Bus cycle time of a Profibus-DP Mono Master system(2 bytes I/O data/slave)

6. SOPC-G11S-PDP Overview

This section contains all necessary information to start-up and configure the SOPC-G11S-PDP.

6.1 Physical interface

Isolation: The bus is galvanically separated from the other electronics with an on board DC/DC converter. Bus signals (A-line and B-line) are isolated via opto couplers.

Profibus-DP communication ASIC: SPC3 chip from Siemens.

Bus connection: The SOPC-G11S-PDP connects to the profibus network with a 9-pin female DSUB connector. For the pin layout, refer to Table 1.

Pin	Name	Function
Housing	Shield	Connected to PE
1	Not Connected	-
2	Not Connected	-
3	B-Line	Positive RxD/TxD according to RS 485 specification
4	RTS	Request To Send *
5	GND BUS	Isolated GND from RS 485 side *
6	+5V BUS	Isolated +5V from RS 485 side *
7	Not Connected	-
8	A-Line	Negative RxD/TxD according to RS 485 specification
9	Not Connected	-

Table 1 Pin Layout

- +5V BUS and GND BUS are used for bus termination. Some devices, like optical transceivers (RS485 to fibre optics) might require external power supply from these pins. RTS is used in some equipment to determine the direction of transmission. In standard applications only A-Line, B-Line and Shield are used.

6.2 Configuration

6.2.1 Baudrate

The baudrate on a Profibus-DP network is set during configuration of the master and only one baudrate is possible in a Profibus-DP installation. The SOPC-G11S-PDP has an auto baudrate detection function and the user does not have to configure the baudrate on the module. Refer to Table 2 for the baudrates supported.

Baudrates supported by SOPC-G11S-PDP
9.6 kbit/s
19.2 kbit/s
93.75 kbit/s
187.5 kbit/s
500 kbit/s
1.5 Mbit/s
3 Mbit/s
6 Mbit/s
12 Mbit/s

Table 2 Supported baudrates

6.2.2 Termination

The end nodes in a Profibus-DP network has to be terminated to avoid reflections on the bus line. The SOPC-G11S-PDP is equipped with a termination switch to accomplish this in an easy way. If the module is used as the first or last module in a network the termination switch has to be in ON position. Otherwise the switch has to be in OFF position.

Please Note: If an external termination connector is used the switch must be in OFF position.

Termination switch ON	Bus termination enabled If the module is the last or first module, the bus termination has to be set on, or an external termination connector has to be used
Termination switch OFF	Bus termination disabled

6.2.3 Node Address

Before power-on the SOPC-G11S-PDP the node address has to be set. This is done with two rotary switches on the module, this enables address settings from 1-99 in decimal format. Looking at the front of the module, the leftmost switch is used for the ten setting and the rightmost switch is used for the setting of the integers.

Example:

$$\text{Address} = (\text{Left Switch Setting} \times 10) + (\text{Right Switch Setting} \times 1)$$

Please Note: The node address can not be changed during operation.

6.2.4 PPO-type selection

SOPC-G11S-PDP supports PPO-type 1-4. (Refer to chapter 7.1 for PPO description)

The same PPO type must be set from both the keypad and the master configuration. If the settings do not comply, the SOPC-G11S-PDP will not start exchanging data with the master.

Setting the PPO type from keypad:

The inverter o-type parameters are used to configure the Profibus-DP interface. The o-type parameters are only accessible from the inverter keypad after the Profibus interface has been installed.

PPO type selection is made in parameter o30. After changing this parameter, the drive has to be re-powered for the change to take affect.

o30 data	PPO type selection
0, 1, 6-255	PPO 1
2	PPO 2
3	PPO 3
4	PPO 4
5	PPO 2

Table 3 PPO type selection

Setting the PPO type from master:

Identification bytes are transmitted in the configuration frame of the Profibus -DP master. These bytes define the PPO type of the user data frame. The identification bytes are included in the GSD-file (refer to chapter chapter 8) that is used during configuration of the master. For how to configure the Profibus-DP master, please refer to the manual for the actual master.

6.2.5 Changeover of communications

In order to enable the inverter control through the communication (by command data and operation data), the inverter function code "H30: Serial link (Function selection)" should be configured for a value of 1-3. The reading and writing of function data and functions are possible at any time regardless of the setting of Function code H30.

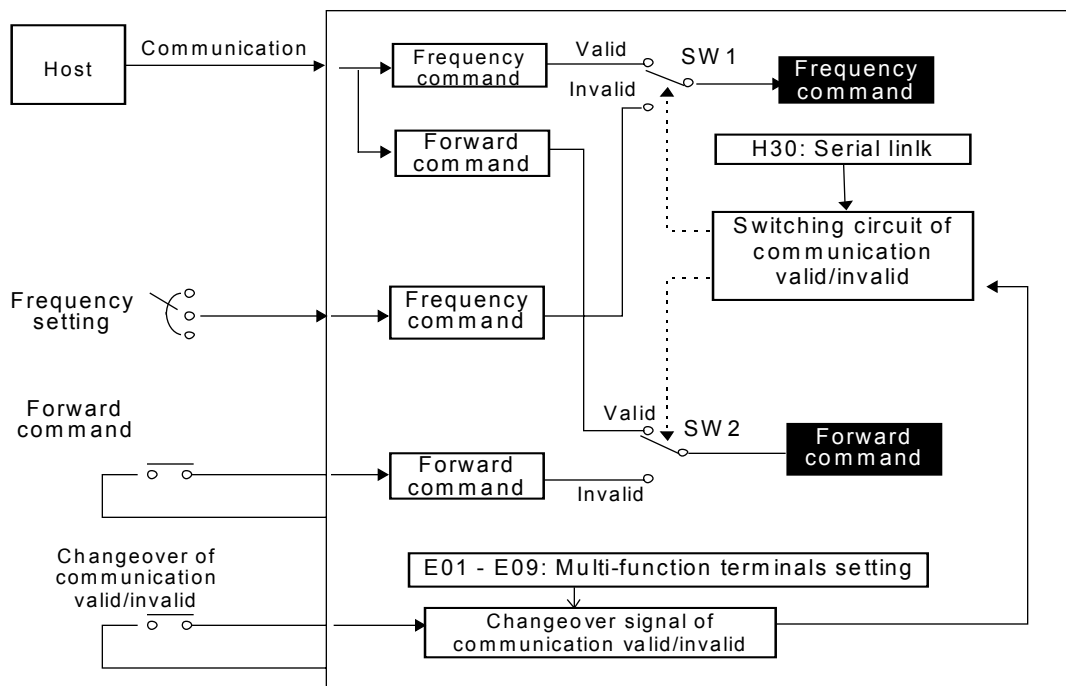

6.2.5.1 Changeover method for communication control

The changeover of the communication control can be performed by the multi-function command terminals (terminals X1-X9) on the inverter. However, it is necessary to configure the inverter's multi-function command input terminals (E01 – E09: X1–X9 terminals function) to the link operation selection (Data 24). If the multi-function command terminals have not been set to the link operation selection, the communication becomes valid automatically.

Input terminals	State
OFF	Communication invalid mode
ON	Communication valid mode (H30 setting)

Note:

- 1) Since all memories are initialized at switching power supply on, the command data and operation data must be write again from the upstream units.
- 2) Even when the communication is invalid, the writing of command data and operation data is valid, but it is not reflected by SW1 • SW2. The changeover without shock is possible by the way the data is set prior to the transition.

6.2.5.2 Link function configuration (operation selection)

The setting (valid/invalid) for command data and operation data during the communication valid period is possible individually by the setting of "H30: Serial link (Function selection)". (By making the communication always valid without setting at the multi-function terminals, changeover for the H30 data valid/invalid can change over the communication valid/invalid, similar to the changeover with multi-function command terminals.)

Link function H30	During communication is valid		During communication is invalid
	SW1 (Command data)	SW2 (Operation data)	SW1, SW2
0	Invalid	Invalid	Invalid
1	Valid	Invalid	
2	Invalid	Valid	
3	Valid	Valid	

6.2.5.3 Coexistence of link (option) and RS485 (or Modbus RTU) communication

When the link options (such as T link, field bus, etc.) are mounted on the inverter, the communication is positioned as described below and the functions are restricted.

Link: The operation through the fieldbus (either one of command data and operation data or both), the operation monitoring, and the reading and changing of functions are possible.

RS485: The operation monitoring and the reading and changing of inverter configuration functions codes is possible (Operation through the RS485 communication is impossible).

Note:

- 1) The communication valid bit of M14: Operating state becomes the state signal of link option and not of RS485.
- 2) When the command data and operation data are accessed from RS485, NAK is returned.
- 3) If the writing of functions is performed through this communication during the writing of functions by the link, NAK (no writing right error) is returned.

6.2.6 Fast stop

When the drive is fast stopped, bit 2 (OFF3 command) in the Control Word, the ramp time specified in Dec time 4 (parameter E15) is used. Refer to chapter 7.2.1 for detailed information about the Control Word.

6.2.7 Configuration of PCD word 1-4

Assigning parameters to PCD word 1-4 (refer to chapter 7.2.3) can be performed in two ways:

1. From keypad (o31-o38)
2. From network (PNU 915,916)

After changing these parameters the drive has to be re-powered for the change to take affect.

Assignment from keypad

Assignment of PCD write word 1-4 (PLC -> Drive):

- o31 = Communication number for parameter transferred in PCD1
- o32 = Communication number for parameter transferred in PCD2
- o33 = Communication number for parameter transferred in PCD3
- o34 = Communication number for parameter transferred in PCD4

Assignment of PCD read word 1-4 (Drive ->PLC):

- o35 = Communication number for parameter transferred in PCD1
- o36 = Communication number for parameter transferred in PCD2
- o37 = Communication number for parameter transferred in PCD3
- o38 = Communication number for parameter transferred in PCD4

Assignment from profibus network

Assignment of PCD write word 1-4 (PLC -> Drive) with parameter 915:

- 915, index 1 = Communication number for parameter transferred in PCD1
- 915, index 2 = Communication number for parameter transferred in PCD2
- 915, index 3 = Communication number for parameter transferred in PCD3
- 915, index 4 = Communication number for parameter transferred in PCD4

Assignment of PCD read word 1-4 (Drive ->PLC) with parameter 916.

- 916, index 1 = Communication number for parameter transferred in PCD1
- 916, index 2 = Communication number for parameter transferred in PCD2
- 916, index 3 = Communication number for parameter transferred in PCD3
- 916, index 4 = Communication number for parameter transferred in PCD4

Please Note:

1. PCD words 1-4 are only enabled if PPO 2 or 4 is selected.
2. Communication numbers are within the range 1-255. See Section 9 for an index of inverter communication numbers. If a communication number is set to 0, the actual PCD word will be ignored.

6.3 Action at communication error

In case of occurring transmission errors (communication cutoff with the master), the following actions can be selected.

1) Select action when error is detected. (o27)

o27	Action at error detection		Remarks
0	Immediate forced stop	Er5	
1	Continue operation within o28 time and stop	Er5	Continue operation using the command just before the error within o28 time, but when restoring, operate following to the designation of communication.
2	Continue operation according to the last command received until restoration of the communication. If the communication is not restored before the o28 time expires, then immediate forced stop.	Er5	
3	Continue operation till restoration of the communication, and after the restoration, follow to designation of communication.	Automatic restoration after restoring communication	

2) Setting time of timer at error (o28)

0.0 – 60.0s

In a case of o27=0 (Mode of immediate forced stop at communication error detection)

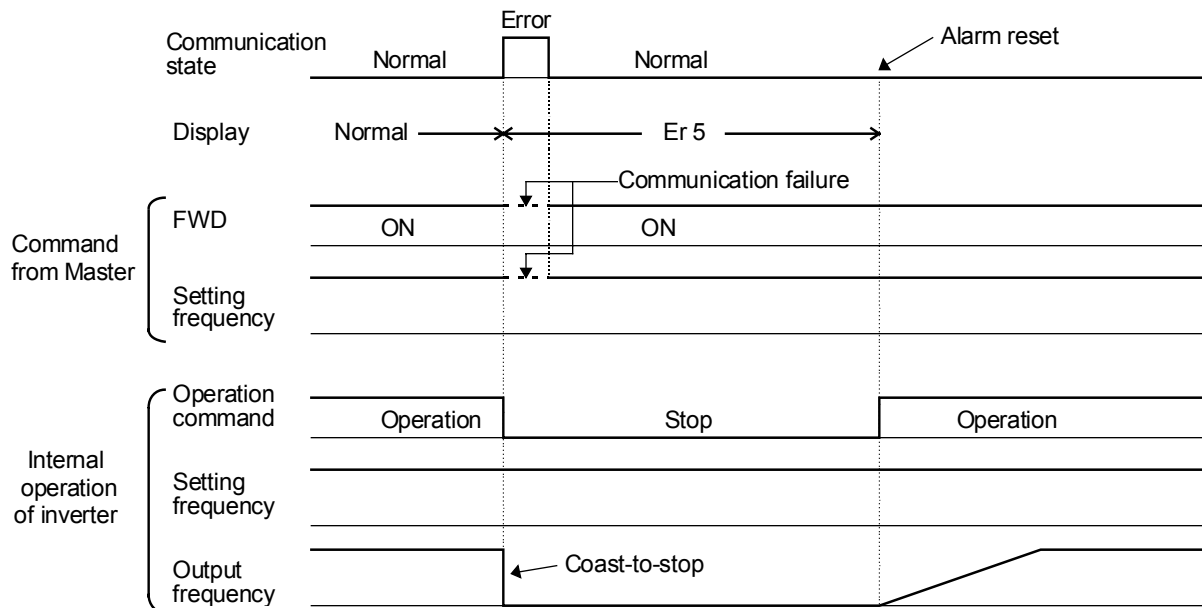

In a case of o27=1, o28=5.0 s (Mode of immediate forced stop after 5 s at occurring communication error)

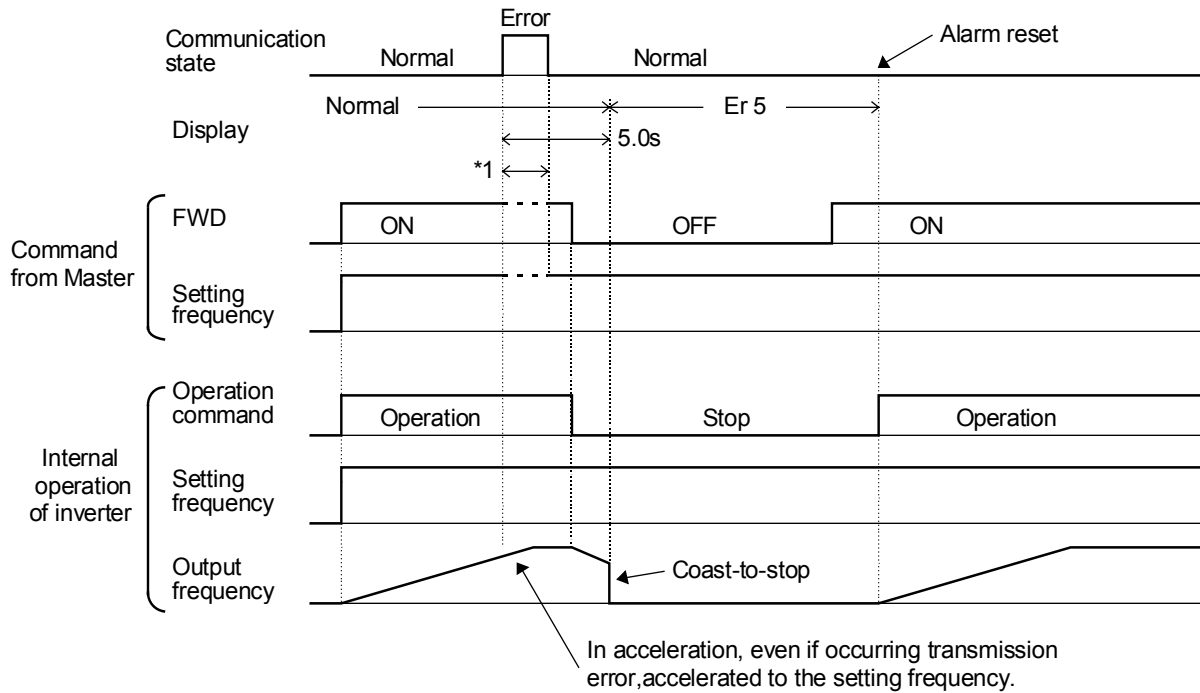

*1) In a period until restoring the communication, the last commands (command data and operation data) received before the error are kept.

In a case of o27=2, o28=5.0 s (The communication is not restored for 5.0 sec after error detection, and inverter trips Er5.)

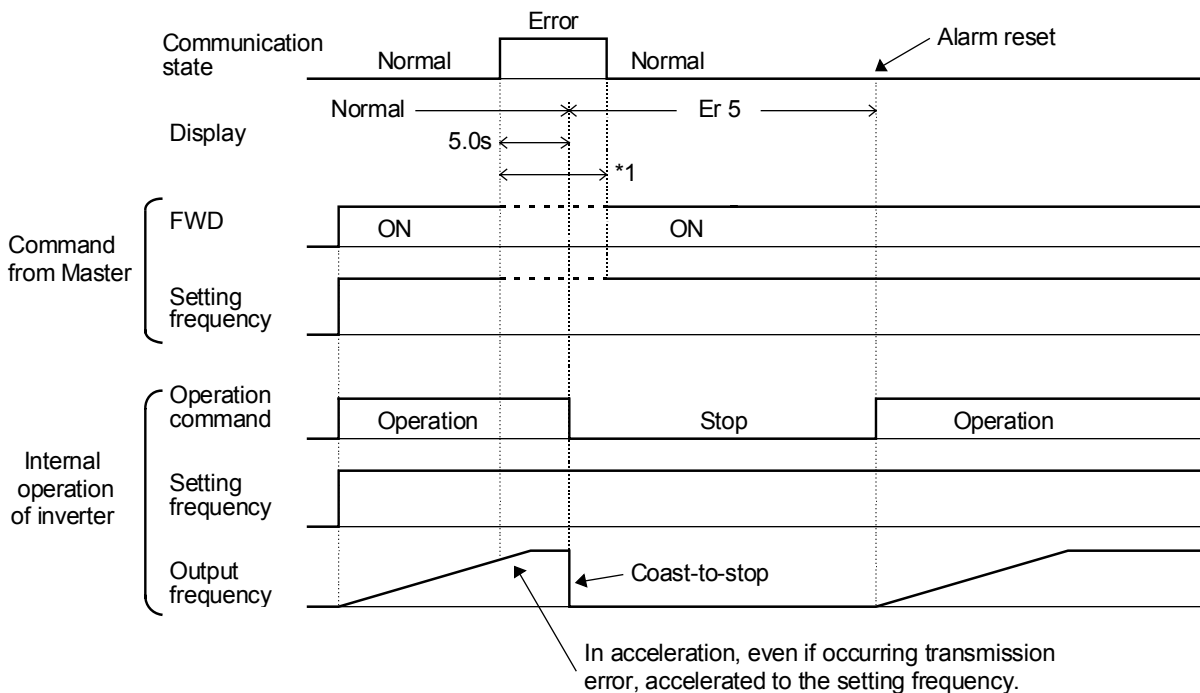

In a case of o27=2, o28=5.0 s (A communication error occurs, but restored within 5 s.)

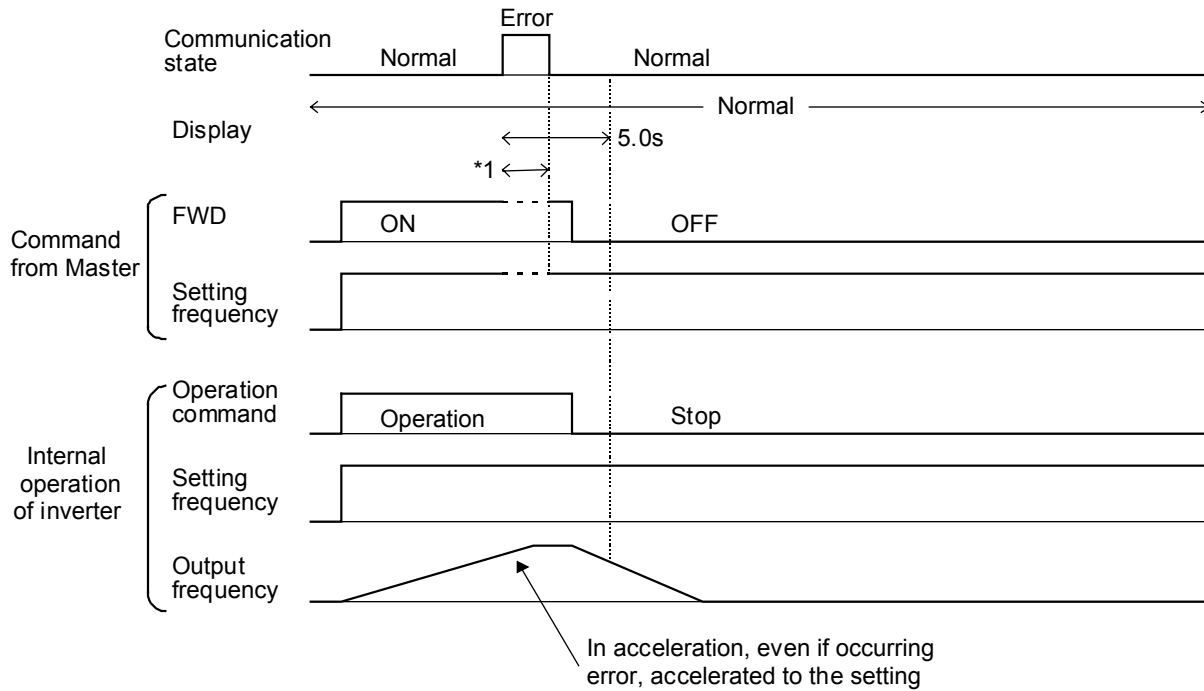

*1) In a period until restoring the communication, the commands (command data and operation data) just before the error are kept.

In a case of o27=3 (When a communication error occurs, the operation continues)

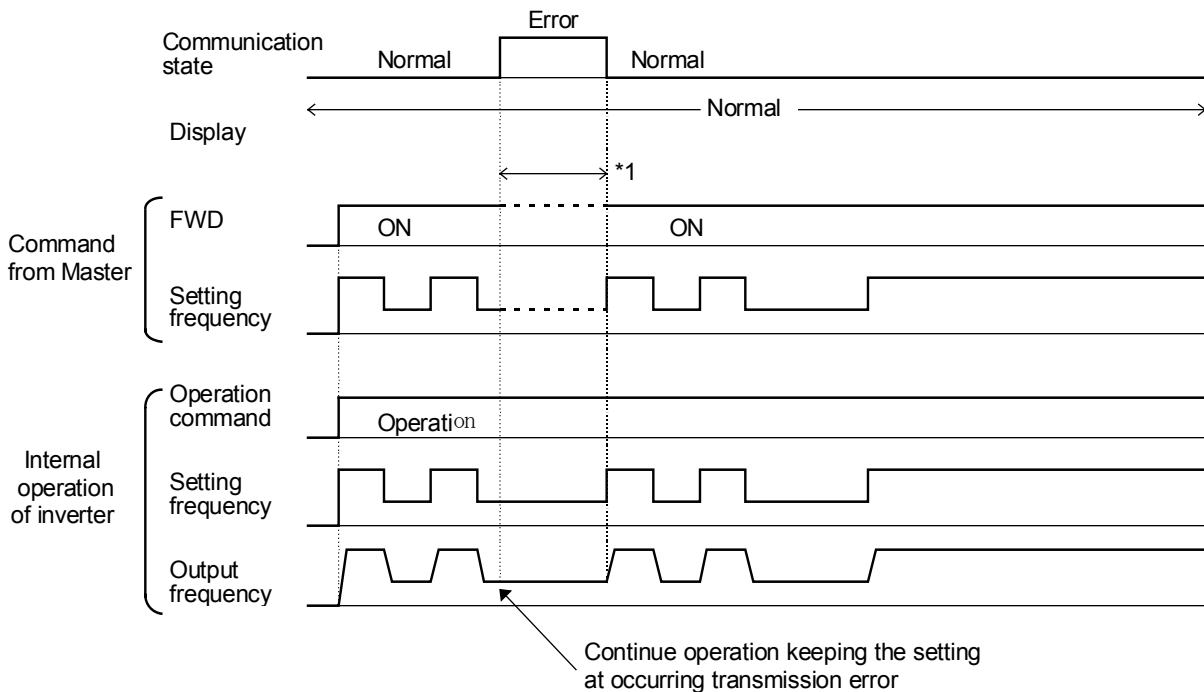

6.4 Indication LED's

The SOPC-G11S-PDP is equipped with four LED's. The function of the LED's are described in Figure 3 and Table 4.

1. Not used
2. On-Line
3. Off-Line
4. Fieldbus diagnostics

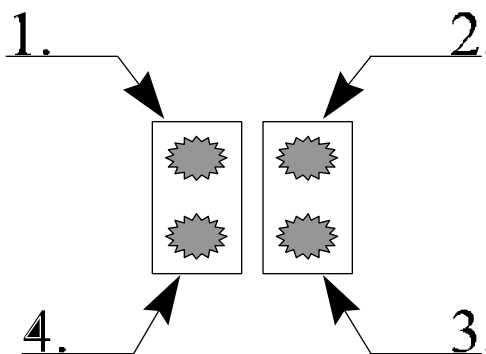

Figure 3 LED's

Name	Color	Function
Fieldbus diagnostics	Red	Flashing Red 1 Hz - Error in configuration: PPO-type set in parameter o30 does not match PPO-type set during configuration of the network. Flashing Red 4 Hz - Error in initialization of the Profibus communication ASIC. Turned Off - No diagnostics present
On-Line	Green	Indicates that the module is On-Line on the fieldbus. Green - Module is On-Line and data exchange is possible. Turned Off - Module is not On-Line
Off-Line	Red	Indicates that the module is Off-Line on the fieldbus. Red - Module is Off-Line and no data exchange is possible. Turned Off - Module is not Off-Line

Table 4 LED functionality

7. Operating the drive via Profidrive profile

This section describes how to control drive via control word/status word and how to access drive parameters.

7.1 PPO- description

The structure of the user data is designated as parameter process data objects (PPO) in the Profidrive profile. The profile defines five PPO types, where SOPC-G11S-PDP supports PPO1-PPO4.

There are PPO's with a parameter area (PCV) and a process data area (PCD). There is also PPO's that consist exclusively of process data (PCD).

1. PPO1 consists of the PCV area and 2 words PCD.
2. PPO2 consists of the PCV area and 6 words PCD.
3. PPO3 consists only of 2 words PCD.
4. PPO4 consists only of 6 words PCD.

The PPO type is defined in the Profibus-DP master parameter settings and must comply with the setting in parameter o30 (refer to chapter 6.2.4)

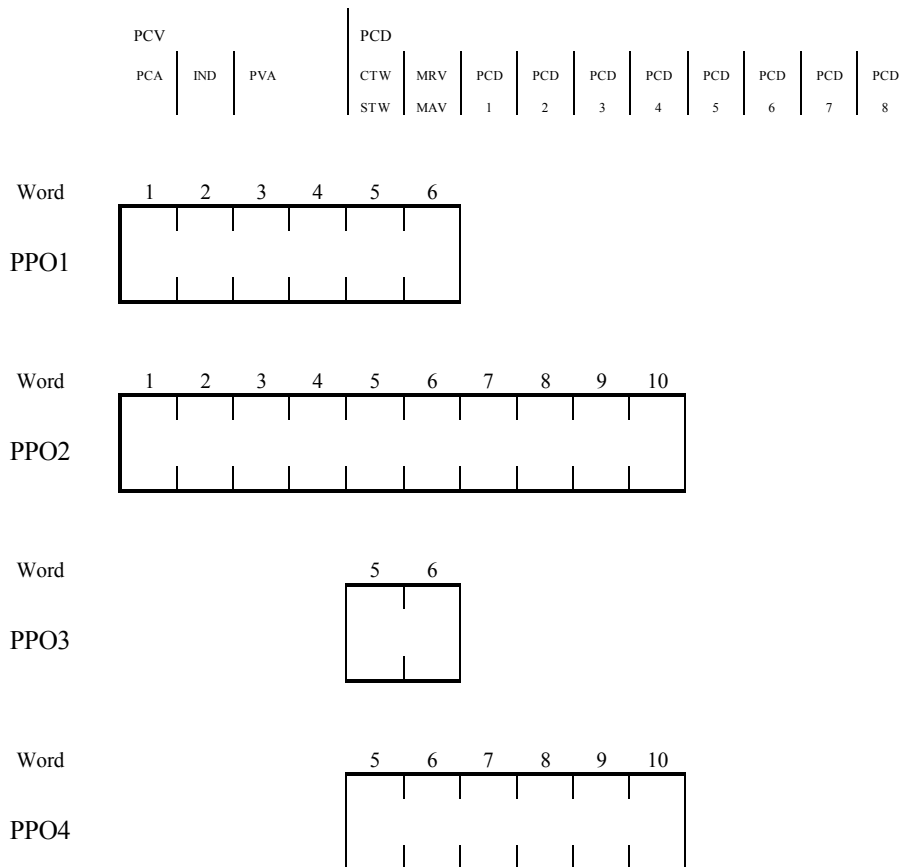

Please Note: PPO type is selected at power-up and can not be changed in run-time.

7.2 PCD-part

In this chapter the process data part (PCD) of a PPO is discussed.

The PCD part consists of a fixed part (all PPO's) and a parameterable part (only PPO 2 & 4).

In the fixed part, control word and speed reference are transferred to the drive while status word and actual output frequency are transferred from the drive.

In the parameterable part, PCD word 1-4, the user can configure what parameters that should be transferred to/from the drive every bus-cycle.

7.2.1 Control- / status word

This section describes how to operate the drive with the control-/status word. Text written in *italic* refers to the actual state in the profdrive state diagram (refer to Figure 4).

Profdrive Control Word:

The control word is used to send control commands to the inverter (PLC->Drive).

<u>Bit # of control word</u>	<u>Bit = 0</u>	<u>Bit = 1</u>
0	OFF1 (normal stop)	ON1
1	OFF2 (coast stop)	ON2
2	OFF3 (fast stop)	ON3
3	Operation disabled	Operation enabled
4	Ramp generator disabled	Condition for operation
5	Stop ramp generator	Ramp generator enabled
6	Setpoint disabled	Setpoint enabled
7	No function	Fault acknowledge
8	Not used	Not used
9	Not used	Not used
10	Data not valid	Data valid
11	No function	Reversing
12-15	Not used	Not used

Bit 0, OFF1/ON1:

Bit=0: Normal stop that uses deceleration time specified in DEC TIME1 (Enter *OFF1 active state*). When output frequency = 0 the drive output is disabled.

Bit=1: Drive can be started if all other start conditions are fulfilled.

Bit 1, OFF2/ON2:

Bit=0: Drive coast to stop (Enter *OFF2 active state*). Returns to *Switch-on inhibit state*.

Bit=1: Drive can be started if all other start conditions are fulfilled.

Bit 2, OFF3/ON3:

Bit=0: Fast stop that uses deceleration time specified in DEC TIME4 (Enter *OFF3 active state*). When output frequency = 0 the drive output is disabled.

Bit=1: Drive can be started if all other start conditions are fulfilled.

Bit 3, Operation disabled/enabled

Bit=0: Drive coast to stop (Enter *Inhibit operation state*).

Bit=1: Drive can be started if all other start conditions are fulfilled.

Bit 4, Ramp generator disabled/ Condition for operation

Bit=0: Output frequency is set to 0. Inverter remains in Running state.

Bit=1: Drive can be started if all other start conditions are fulfilled.

Bit 5, Stop ramp generator/ Ramp generator enabled

Bit=0: Actual output frequency is frozen. Changes to frequency setpoint has no affect.

Bit=1: Drive can be started if all other start conditions are fulfilled.

Bit 6, Setpoint disabled/enabled

Bit=0: Normal stop that uses deceleration time specified in DEC TIME1.

Bit=1: Drive can be started if all other start conditions are fulfilled.

Bit 7, No function/ Fault acknowledge

Bit=0: No fault acknowledge.

Bit=1: Fault is acknowledged on positive edge, i.e. bit = 0 then 1 (Enter *Switch-on inhibit state*).

Bit 10, Data invalid/ Data valid

Bit=0: The control word and frequency setpoint (from PROFIBUS) are not activated.

Bit=1: The control word and frequency setpoint (from PROFIBUS) are activated.

Bit 11, No function/Reversing

Bit=0: Drive is not reversing.

Bit=1: Drive is reversing.

Profidrive Status Word:

The status word indicates the status of the inverter (Drive -> PLC).

<u>Bit # of status word</u>	<u>Bit = 0</u>	<u>Bit = 1</u>
0	Not ready for switch-on	Ready to switch-on
1	Not ready for operation	Ready for operation
2	Operation inhibited	Operation enabled
3	No fault	Trip
4	OFF2	ON2
5	OFF3	ON3
6	Start disable	Start enable
7	No alarm	Alarm
8	Frequency not equal to setpoint	Frequency equal to setpoint
9	Local control	Bus control
10	Frequency out of range	Frequency within range
11-15	Not used	Not used

Bit 0, Not ready for switch-on / Ready to switch-on

Bit=0: Control word bit 0,1 or 2 (OFF1, OFF2, OFF3) is set to 0, or the drive has tripped.

Bit=1: Control word bit 0 = 0 and bits 1, 2,10 are set to 1 (*Ready to switch-on state*).

Bit 1, Not ready for operation / Ready for operation

Bit=0: Control word bit 0,1 or 2 (OFF1, OFF2, OFF3) is set to 0, or the drive has tripped.

Bit=1: Control word bit 0,1 and 2 are set to 1, and the drive has not tripped (*Ready state*).

Bit 2, Operation inhibited / Operation enabled

Bit=0: Control word bit 0,1,2 or 3 (OFF1, OFF2, OFF3 or Operation disabled) is set to 0, or the drive has tripped.

Bit=1: Control word bit 0,1,2 and 3 are set to 1, and the drive has not tripped (*Enable operation state*).

Bit 3, No Fault/ Fault (Trip)

Bit=0: Drive has not tripped.

Bit=1: Drive is tripped. Fault reset from keypad or bit 7 in Control Word is needed to reset the drive after the fault is cleared.

Bit 4, OFF2/ ON2

Bit=0: OFF2 command active. Control word bit 1 = 0 (*OFF2 active state*).

Bit=1: Control word bit 1 = 1.

Bit 5, OFF3/ ON3

Bit=0: OFF3 command active. Control word bit 2 = 0 (*OFF3 active state*).

Bit=1: Control word bit 2 = 1.

Bit 6, Start disable/ Start enable

Bit=0: Control word bit 0 = 0 and bit 10 = 1 (*Not Ready to switch-on state*).

Bit=1: Control word bit 1 or 2 (OFF2, OFF3) is set to 0 or fault trip has been acknowledged (*Switch-on inhibit*).

Bit 8, Frequency not equal to setpoint/ Frequency equal to setpoint

Bit=0: Actual output frequency does not equal frequency setpoint (i.e. motor is accelerating / decelerating).

Bit=1: Actual output frequency does equal frequency setpoint.

Please Note: The frequency tolerance width is configured in parameter E30.

Bit 9, Local control/ Bus control

Bit=0: Run command and Frequency setting are invalid via Profibus.

Bit=1: Run command or Frequency setting are valid via Profibus.

Bit 10, Frequency out of range/ Frequency within range

Bit=0: Actual output frequency is lower than the limit specified in parameter E31 and E32.

Bit=1: Actual output frequency is above or equal to the limit specified in parameter E31 and E32 .

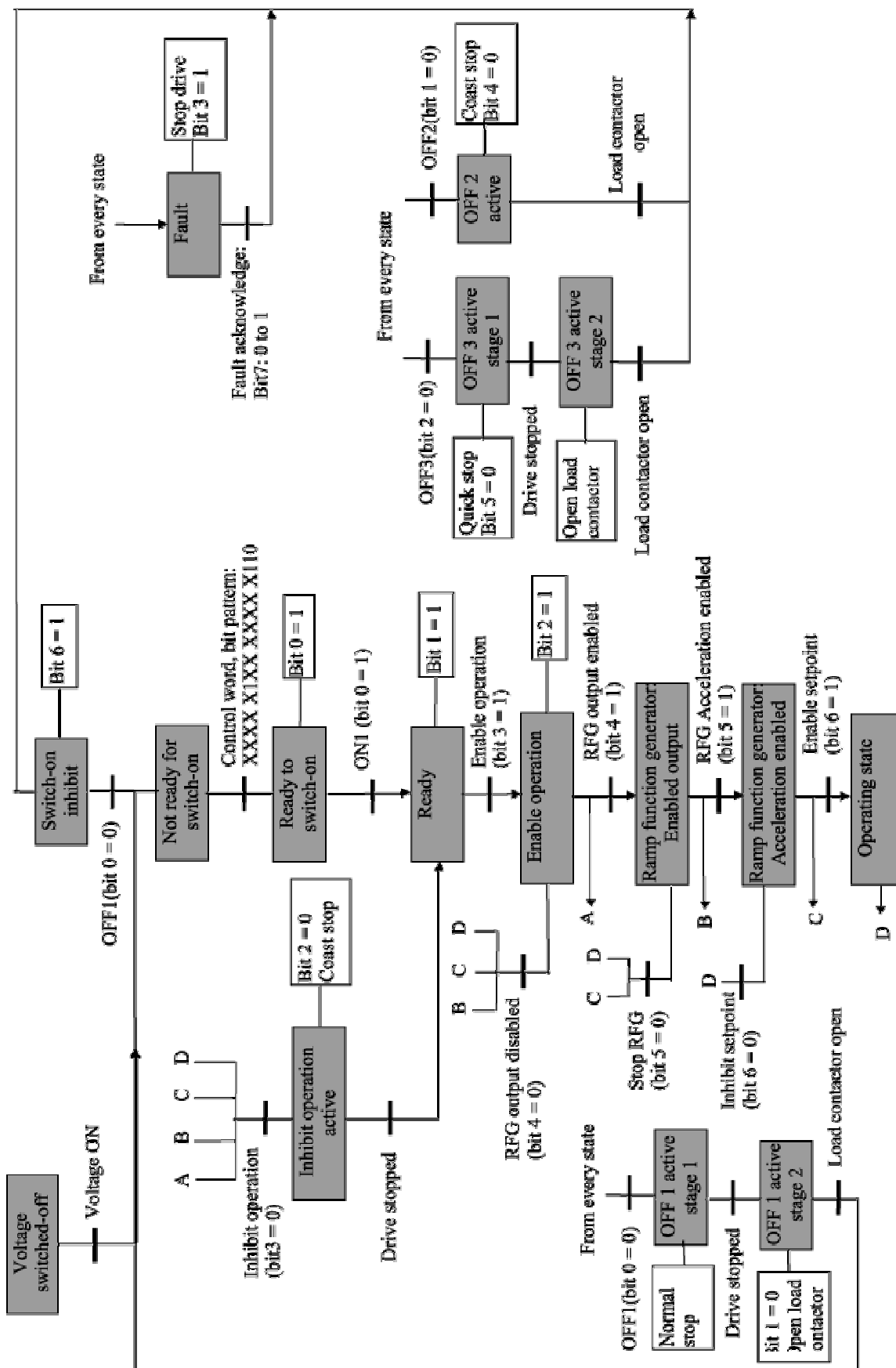

7.2.2 Frequency setpoint/ Actual frequency

The data format is “Standardized value”, where 0 hex = 0 % and 4000 hex is 100% of Max. frequency specified in parameter F03 or A01.

Standardized value

A linear value.

0%=0 (0h), 100% is 2¹⁴ (4000h)

Data type	N2
Range	-200%...200%-2 ⁻¹⁴
Resolution	2 ⁻¹⁴ = 0.0061%
Length	2 bytes

Notation: 2's complement notation.

MSB is 1st bit after sign bit in 1st byte.

Sign bit = 0 = positive number

Sign bit = 1 = negative number

Bit	8	7	6	5	4	3	2	1
Byte 1	SIGN	2 ⁰	2 ⁻¹	2 ⁻²	2 ⁻³	2 ⁻⁴	2 ⁻⁵	2 ⁻⁶
Byte 2	2 ⁻⁷	2 ⁻⁸	2 ⁻⁹	2 ⁻¹⁰	2 ⁻¹¹	2 ⁻¹²	2 ⁻¹³	2 ⁻¹⁴

7.2.3 PCD word 1-4

In PCD word 1-4 the user can determine which drive parameters that should be transferred to/from the drive every bus-cycle. Refer to chapter 6.2.7 for configuration of PCD word 1-4.

7.3 PCV-part

The parameter part (PCV) is fixed to 4 words and can be used for reading and/or updating the parameters in the drive one by one. Requests and responses is a handshake procedure and cannot be batched, meaning that if the master sends out a read/write request, it has to wait for the response, before it sends a new request.

The PCV is further divided into three parts; PCA- Parameter Characteristics (1 word), IND – Subindex (1 word) and PVA- Parameter value (2 words).

PCA handling:

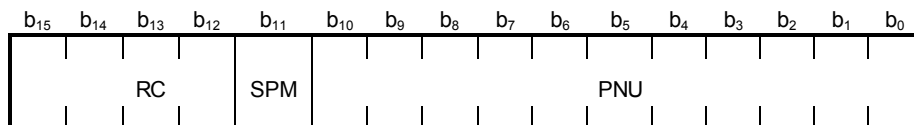

Figure 4 PCA word

RC: Request/response characteristics (Range 0-15)

SPM: Toggle bit for Spontaneous Messages, not used by SOPC-G11S-PDP.

PNU: Parameter number. Range 1-255 for G11S specific parameters and 900-999 for profidrive specific parameters. Please refer to chapter 7.5 for which profidrive specific parameters that are supported

Request/Response handling

The RC portion of the PCA word defines the request/response that may be issued.

Since all parameters in GP10 / VG10 are “word type” (16 bits), the PVA part will transmit parameter values in bytes 7 and 8. (Byte 5 and 6 are reserved for parameters that are “long word type” (32 bits)).

If the Request/Response contains array elements, the high byte (byte 3) of the IND word will carry the array subindex.

RC content

Request: Function:

0	No request
1	Request parameter value
2	Change parameter value (word)
3	Change parameter value (long word)*
4	Request description element*
5	Change description element*
6	Request parameter value (array)
7	Change parameter value (array word)
8	Change parameter value (array long word)*
9	Request number of array elements
10-15	Not used

Response: Function:

0	No response
1	Transfer parameter value (word)
2	Transfer parameter value (long word)*
3	Transfer description element*
4	Transfer parameter value (array word)
5	Transfer parameter value (array long word)*
6	Request number of array elements
7	Request rejected (including fault number, see below)
8	Not parameter change rights by PCV interface
9-15	Not used

If the drive rejects a request from the master, the RC word in the PPO-read will indicate this by assuming value 7. The describing fault number (refer to Table 5) will be found in the PVA part.

* Not supported by SOPC-G11S-PDP

<u>Fault number</u>	<u>Interpretation</u>
0	Non-admissible parameter number
1	Parameter value can not be changed
2	Upper or lower limit exceeded
3	Erroneous sub-index
4	No array
5	Incorrect data type
7	Descriptive element cannot be changed
9	Descriptive data not available
11	No parameter change rights
17	Task can not be executed due to operating status
101	Priority of link error
102	Drive communication error
103	Busy communicating with another unit
104	Error during writing
105	Flash segment overflow
106	Illegal task requested

7.4 Example

In this example, PPO1 is used to set parameter S08 (Acceleration time 1) to 4.0 seconds. Also, a Start command and a frequency setpoint (50%) is given.

Request	20	08	00	00	00	00	00	28	04	06/7F*	20	00
Response	10	08	00	00	00	00	00	28	03	37	20	00

In the request message the first two bytes are used for parameter identification. The first digit (2) denotes the function “Change parameter value” (refer to chapter 7.3). The second digit along with the second byte (0 and 08) indicates parameter nr. 8. Bytes 7 and 8 (00 28 = DEC 40) is the parameter value (40 meaning 4.0 seconds). The last four bytes are the Control Word and Frequency setpoint. Control Word value 04 06 -> 04 7F* starts the motor, while 20 00 (refer to 7.2.2) signifies 50 % of the maximum frequency specified in parameter F03 or A01.

In the response message, the first digit (1) indicates the function “Transfer parameter value”. The last four bytes are Status Word and Actual frequency (%).

*To start the drive the profibus state machine must be shifted in a correct way. This may be done in two steps. First the control word should be set to 04 06 (Enter *Ready to switch-on state*) and then to 04 7F (Enter *Operating state*). Refer to the state diagram in Figure 4.

7.5 Profidrive specific parameters

The table below shows which profidrive specific parameters that are supported by SOPC-G11S-PDP.

PNU(Parameter Number)	Description	Range	
915 Indexed assignment of PCD write word 1-4	Refer to chapter 6.2.7 for how to assign PCD words.	1-255	R/W
916 Indexed assignment of PCD read word 1-4	Refer to chapter 6.2.7 for how to assign PCD words.	1-255	R/W
918 Profibus-DP slave address	Returns address switch setting.	1-99	R
927 Parameter edit rights	0 - Parameter edit rights from network not possible. 1- Parameter edit rights from network possible	0, 1	R/W
947 Indexed Fault memory	Index = 1 Fault memory 0 Index = 2 to 8 Fixed to 0 Index = 9 Fault memory (1 st prior) Index = 10 to 16 Fixed to 0 Index = 17 Fault memory (2 nd prior) Index = 18 to 24 Fixed to 0 Index = 25 Fault memory (3 rd prior) Refer to drive parameter M16-M19.	Refer to chapter 7.6 for the malfunction codes.	R
963 PROFIBUS-DP baud rate	Shows the baudrate of the Profibus-DP network. 0 = Baud rate not found 1 = 9.6 Kbaud 2 = 19.2 Kbaud 3 = 45.45 Kbaud 4 = 93.75 Kbaud 5 = 187.5 Kbaud 6 = 500 Kbaud 7 = 1.5 Mbaud 8 = 3.0 Mbaud 9 = 6.0 Mbaud 10 = 12.0 Mbaud	0-12	R

965 Profile version	Returns the Profidrive profile version used in the SOPC-G11S-PDP implementation		R
967 Control Word	Shows the latest received control word in hex format Refer to chapter 7.2.1 for detailed information about the control word.	Bit 0-15	R
968 Status Word	Shows the latest status word in hex format Refer to chapter 7.2.1 for detailed information about the status word.	Bit 0-15	R
970 Reset to factory setting	Parameter for starting the parameter reset to factory setting. After completion of the factory setting, this parameter is also reset to it's original value, 1. 0 - Start parameter reset 1- No parameter reset Caution: A reset causes the loss of all parameter changes.	0,1	R/W

Table 5 Profidrive parameters

7.6 Malfunction codes

Inverter code (M16-M19)	Description		Malfunction code (HEX)
0	No alarm	-	0000
1	Overcurrent (During acceleration)	OC1	2301
2	Overcurrent (During deceleration)	OC2	2302
3	Overcurrent (While running at constant speed)	OC3	2303
5	Ground fault	EF	2330
6	Overvoltage (During acceleration)	OU1	3211
7	Overvoltage (During deceleration)	OU2	3212
8	Overvoltage (While running at constant speed)	OU3	3213
10	Undervoltage	LU	3220
11	Input phase lose	Lin	3130
14	DC Fuse blown	FUS	5450
17	Overheat of heat sink in inverter	OH1	4310
18	External alarm input	OH2	9000
19	Overheat of unit internal temp.	OH3	4110
22	Overheat of DB resistance	dbH	4210
23	Electronic thermal overload relay (Motor 1)	OL1	2211
24	Electronic thermal overload relay (Motor 2)	OL2	2212
25	Electronic thermal overload relay (Inverter)	OLU	2200
27	Overspeed	OS	7310
28	PG error	Pg	7301
31	Memory error	Er1	5500
32	KEYPAD panel communication error	Er2	7520

33	CPU error	Er3	5220
34	Option communication error	Er4	7510
35	Option error	Er5	7511
36	Operating proc. error	Er6	F004
37	Output phase loss error	Er7	7200
38	RS485 communication error	Er8	B100

8. Parameters specific for communication

To operate the inverters or to monitor the state via communication, the following parameters are available for communication in addition to the configuration functions of the inverters. These parameters are a common data format applicable to inverter types on and after GP10 / VG10 series, so that it is possible to access different inverter types by the same program on the host side.

8.1 Command data

Code	Name	Unit	Variable range	Min. unit	Read/write
S01	Setting frequency (p.u.)	-	-20000–20000 (Maximum frequency at ± 20000)	1	R/W
S05	Setting frequency	Hz	0.00–400.00 (GP10: 0.00–120.00)	0.01	R/W

R: Reading

W: Writing

Note:

- 1) The data writing exceeding the setting range is possible, but the actual action will be restricted within the inverter.
- 2) When the command data is read, it is not the command data of actual action but the command data communicated before (the final command data can be obtained by reading of the monitoring data described later).

8.2 Operation command data

Code	Name	Unit	Variable range	Min. unit	Read/write
S06	Operation command	-	Refer to the data format [11]	-	R/W
S07	Universal Do	-	Refer to the data format [12]	-	R/W
S12	Universal Ao	-	-20000–20000 (100% output at ± 20000)	1	R/W

Note:

- 1) Since X1–X9 are multi-function inputs, it is necessary to set the functions with E01–E09.
- 2) The alarm reset is executed, when RST signal changes from ON to OFF even there are no alarming factors.
- 3) Universal Do is a function utilizing inverter's Do via transmission.
(In detail, refer to the detail descriptions E20–E24 in "Function Explanation" in the instruction manual of inverter).
- 4) The data writing exceeding the setting range is possible, but the actual action will be restricted within the inverter.

5) When the operation commands are instructed through the communication, the relation to the inverter terminal commands becomes as follows.

Function			Command	
Classification	Symbol	Name	Transmission	Terminal block
Multi-function command	Operation command	FWD/REV	FWD/REV command	
	0-3	SS1, 2, 4, 8	Valid	Invalid
	4, 5	RT1, RT2		
	6	HLD	Invalid	
	7	BX	Valid	
	8	RST		
	9	THR	Invalid	Valid
	10	JOG	Invalid	
	11	Hz2/Hz1	Valid	
	12	M2/M1		
	13	DCBRK		
	14	TL2/TL1		
	15, 16	SW50, SW60	Switching operation between line and inverter (50, 60Hz)	
	17, 18	UP, DOWN	Invalid	Valid
	19	WE-KP	Valid	
	20	Hz/PID		
	21	IVS	Inverse mode changeover (terminals 12 and C1)	
	22	IL	Invalid	Valid
	23	Hz/TRQ	Valid	Invalid
	24	LE	Invalid	
	25	U-DI		
	26	STM	Valid	
	27	PG/Hz	SY-PG enable	
	28	SYC	Valid	Invalid
	29	ZERO		
	30	STOP1		
	31	STOP2	Invalid	Valid
	32	EXITE	Pre-exciting command	

8.3 Function data

Code	Name	Unit	Variable range	Min. unit	Read/Write
S08	Acceleration time F07	s	0.1–3600.0	0.1	R/W
S09	Deceleration time F08	s	0.1–3600.0	0.1	R/W
S10	Torque limit level 1 (Driving) F40	%	20.00–200.00 (GP10 : 20.00–150.00), 999	1.00	R/W
S11	Torque limit level 2 (Braking) F41	%	0.00, 20.00–200.00 (GP10 : 20.00–150.00), 999	1.00	R/W

Note:

- 1) The writing to out of the range is treated as out of range error.
- 2) The acceleration and deceleration time S08 and S09 are assigned to "F07: Acceleration time,P" and "F08: Deceleration time 1" respectively.
- 3) The torque limit level 1 and 2 of S10 and S11 are assigned to "F40: Torque limit 1 (Driving)" and "F41: Torque limit 1 (Braking)" respectively

8.4 Monitoring data

Code	Description	Unit	Range	Min. unit	Read/Write
M01	Setting frequency (Final data)	-	-20000-20000 (Maximum frequency at ± 20000)	1	R
M05	Setting frequency (Final data)	Hz	0-400.00 (GP10: 0.00-120.00)	0.01	R
M06	Output frequency 1	-	-20000-20000 (Maximum frequency at ± 20000)	1	R
M07	Torque calculation value	%	-200.00-200.00	0.01	R
M08	Torque current	%	-200.00-200.00	0.01	R
M09	Output frequency 1	Hz	0.00-400.00 (GP10:0.00-120.00)	0.01	R
M10	Input power	%	0.00-200.00	0.01	R
M11	Output current	%	0.00-200.00 (Inverter rating at 100.00)	0.01	R
M12	Output voltage	V	0.0-600.0	1.0	R
M13	Operation command (Final data)	-	Refer to the data format [11]	-	R
M14	Operating state	-	Refer to the data format [13]	-	R
M15	Y1-Y5 output terminal data	-	Refer to the data format [12]	-	R
M16	Fault memory 0	-	Refer to 7.6 Malfunction codes	-	R
M17	Fault memory (1st prior)	-			
M18	Fault memory (2nd prior)	-			
M19	Fault memory (3rd prior)	-			
M20	Operating time	h	0-65535	1	R
M21	DC link circuit voltage	V	0-1000	1	R
M23	Type code	-	Refer to the data format [14]	-	R
M24	Capacity code	-	Refer to the data format [9]	-	R
M25	ROM version	-	0-64999	1	R
M26	Transmission error code	-	Refer to the data format [1]	-	R
M27	Setting frequency at alarming (Final data)	-	-20000-20000 (Maximum frequency at 20000)	1	R
M31	Setting Frequency at alarming (Final data)	Hz	0-400.00 (GP10: 0.00-120.00)	0.01	R
M32	Output frequency at alarming	-	-20000-20000 (Maximum frequency at ± 20000)	1	R
M33	Torque calculation value at alarming	%	-200.00-200.00	0.01	R
M34	Torque current at alarming	%	-200.00-200.00	0.01	R

M35	Output frequency 1 at alarming	Hz	-400.00–400.00 (GP10: -120.00–120.00)	0.01	R
M36	Input power at alarming	%	0.00–200.00	0.01	R
M37	Output current at alarming	%	0.00–200.00 (Inverter rating at 100.00)	0.01	R
M38	Output voltage at alarming	V	0.0–600.0	1.0	R
M39	Operation command at alarming	-	Refer to the data format [11]	-	R
M40	Operating state at alarming	-	Refer to the data format [13]	-	R
M41	Y1-Y5 output terminal data at alarming	-	Refer to the data format [12]	-	R
M42	Operation time at alarming	h	0–65535	1	R
M43	DC link circuit voltage at alarming	V	0–1000	1	R
M44	Inverter internal air temp. at alarming	°C	0–120	1	R
M45	Cooling fin temp. at alarming	°C	0–120	1	R
M46	Life of main circuit capacitor	%	0.0–100.0	0.1	R
M47	Life of printed circuit board capacitor	h	0–65535	1	R
M48	Life of cooling fan	h	0–65535	1	R

Note :

- 1) The output frequency 1 is before slip compensation.
- 2) The output frequency 1 with speed regulator (using option SOPC-G11S-PG) is treated as the synchronous frequency.

9. Parameter data format

The data formats for various parameter data of the inverters are defined here. The data shall be prepared according to the following data format specifications. The instruction manual of inverter shall be referred to for the range and unit of data. The communication number is used to access inverter parameters through the fieldbus option and to configure process data exchange.

9.1 List of parameter data format

Code	Communication No. decimal (Hex.)	Name	Data Format	Code	Communication No. decimal (Hex.)	Name	Data Format
-	0	-	-	M31	45(2D)	Setting frequency at alarming	[5]
S01	1(1)	Setting frequency (p.u.)	[2]			(Final data)	
-	2(2)	-	-	M32	46(2E)	Output frequency at alarming	[2]
-	3(3)	-	-	M33	47(2F)	Torque calculation value at alarming	[6]
-	4(4)	-	-	M34	48(30)	Torque current at alarming	[6]
S05	5(5)	Setting frequency	[5]	M35	49(31)	Output frequency 1 at alarming	[5]
S06	6(6)	Operation command	[11]	M36	50(32)	Input power at alarming	[5]
S07	7(7)	Universal Do	[12]	M37	51(33)	Output current at alarming	[5]
S08	8(8)	Acceleration time	[3]	M38	52(34)	Output voltage at alarming	[3]
S09	9(9)	Deceleration time	[3]	M39	53(35)	Operation command at alarming	[11]
S10	10(A)	Torque limit level 1	[5] *1	M40	54(36)	Operating state at alarming	[13]
S11	11(B)	Torque limit level 1	[5] *1	M41	55(37)	Y1-Y5 output terminal data at alarming	[12]
S12	12(C)	Universal Ao	[2]				
-	13(D)	-	-	M42	56(38)	Operating time at alarming	[1]
-	14(E)	-	-	M43	57(39)	DC link circuit voltage at alarming	[1]
M01	15(F)	Setting frequency (Final data)	[2]	M44	58(3A)	Inverter internal air temp. at alarming	[1]
-	16(10)	-	-				
-	17(11)	-	-	M45	59(3B)	Cooling fin temp. at alarming	[1]
-	18(12)	-	-	M46	60(3C)	Life of main circuit capacitor	[3]
M05	19(13)	Setting frequency (Final data)	[5]	M47	61(3D)	Life of printed circuit board capacitor	[1]
M06	20(14)	Output frequency 1	[2]	M48	62(3E)	Life of cooling fan	[1]
M07	21(15)	Torque calculation value	[6]	-	63(3F)	-	-
M08	22(16)	Torque current	[6]	-	64(40)	-	-
M09	23(17)	Output frequency 1	[5]	-	65(41)	-	-
M10	24(18)	Input power	[5]	-	66(42)	-	-

M11	25(19)	Output current	[5]	-	67(43)	-	-
M12	26(1A)	Output voltage	[3]	-	68(44)	-	-
M13	27(1B)	Operation command (Final data)	[11]	-	69(45)	-	-
M14	28(1C)	Operating state	[13]	F00	70(46)	Data protection	[1]
M15	29(1D)	Y1-Y5 output terminal data	[12]	F01	71(47)	Frequency command 1	[1]
M16	30(1E)	Fault memory 0	[1]	F02	72(48)	Operation method	[1]
M17	31(1F)	Fault memory (1st prior)	[1]	F03	73(49)	Maximum output frequency 1	[1]
M18	32(20)	Fault memory (2nd prior)	[1]	F04	74(4A)	Base frequency 1	[1]
M19	33(21)	Fault memory (3rd prior)	[1]	F05	75(4B)	Rated voltage 1	[1]
M20	34(22)	Operating time	[1]	F06	76(4C)	Maximum output voltage 1	[1]
M21	35(23)	DC link circuit voltage	[1]	F07	77(4D)	Acceleration time 1	[10]
-	36(24)	-	-	F08	78(4E)	Deceleration time 1	[10]
M23	37(25)	Type code	[14]	F09	79(4F)	Torque boost 1	[3]
M24	38(26)	Capacity code	[9]	F10	80(50)	Electronics thermal overload relay 1	[1]
M25	39(27)	ROM version	[1]			(Selection)	
M26	40(28)	Transmission error processing code	[1]	F11	81(51)	Electronics thermal overload relay 1 (Level)	[10]
M27	41(29)	Setting frequency at alarming (Final data)	[2]	F12	82(52)	Electronics thermal overload relay 1	[3]
				F13	83(53)	Electronics thermal overload relay (Braking resistor)	[1]
-	42(2A)	-	-	F14	84(54)	Restart after momentary power failure (Selection)	[1]
-	43(2B)	-	-				
-	44(2C)	-	-				

*1) 999 is treated as 7FFF_H.

Code	Communication No. decimal (Hex.)	Name	Data Format	Code	Communication No. decimal (Hex.)	Name	Data Format
F15	85(55)	Frequency limiter (High)	[1]	E37	135(87)	Overload early warning 2 (level)	[10]
F16	86(56)	Frequency limiter (Low)	[1]	E40	136(88)	Display coefficient A	[10]
F17	87(57)	Gain (for frequency setting signal)	[3]	E41	137(89)	Display coefficient B	[10]
F18	88(58)	Bias frequency	[4]	E43	138(8A)	LED monitor (Display selection)	[1]
F20	89(59)	DC brake (Starting frequency)	[3]	E44	139(8B)	LED monitor (Display at STP mode)	[1]
F21	90(5A)	DC brake (Braking level)	[1]	E45	140(8C)	LCD monitor (Display selection)	[1]
F22	91(5B)	DC brake (Braking time)	[3]	C01	141(8D)	Jump frequency 1	[1]
F23	92(5C)	Starting frequency	[3]	C02	142(8E)	Jump frequency 2	[1]
F24	93(5D)	Starting frequency (Holding time)	[3]	C03	143(8F)	Jump frequency 3	[1]
F25	94(5E)	Stop frequency	[3]	C04	144(90)	Jump frequency (Width)	[1]
F26	95(5F)	Motor sound (Carrier frequency)	[1] *1	C05	145(91)	Multi-step frequency 1	[5]
F27	96(60)	Motor sound (Sound tone)	[1]	C06	146(92)	Multi-step frequency 2	[5]
F30	97(61)	FMA terminal (Voltage adjust)	[1]	C07	147(93)	Multi-step frequency 3	[5]
F31	98(62)	FMA terminal (Function selection)	[1]	C08	148(94)	Multi-step frequency 4	[5]
F33	99(63)	FMP terminal (Pulse rate multiplier)	[1]	C09	149(95)	Multi-step frequency 5	[5]
F34	100(64)	FMP terminal (Voltage adjust)	[1]	C10	150(96)	Multi-step frequency 6	[5]
F35	101(65)	FMP terminal (Function selection)	[1]	C11	151(97)	Multi-step frequency 7	[5]
F36	102(66)	30Ry operation mode	[1]	C20	152(98)	Jogging frequency	[5]
				C30	153(99)	Frequency setting 2	[1]
F40	103(67)	Torque limit 1 (Driving)	[1]	C31	154(9A)	Analog input offset (terminal 12) / Analog input bias (terminal 12)	[4]
F41	104(68)	Torque limit 1 (Braking)	[1]				
F42	105(69)	Torque vector control 1	[1]	C32	155(9B)	Analog input offset (terminal C1) / Analog input gain (terminal 12)	[4]
E01	106(6A)	X1 terminal function	[1]				
E02	107(6B)	X2 terminal function	[1]	C33	156(9C)	Analog filter	[5]
E03	108(6C)	X3 terminal function	[1]	P01	157(9D)	Motor 1 (Number of poles)	[1]
E04	109(6D)	X4 terminal function	[1]	P02	158(9E)	Motor 1 (Capacity)	[5]
E05	110(6E)	X5 terminal function	[1]	P03	159(9F)	Motor 1 (Rated current)	[10]
E06	111(6F)	X6 terminal function	[1]	P04	160(A0)	Motor 1 (Auto-tuning)	*4
E07	112(70)	X7 terminal function	[1]	P05	161(A1)	Motor 1 (On-line tuning)	[1]

E08	113(71)	X8 terminal function	[1]	P06	162(A2)	Motor 1 (No-load current)	[10]
E09	114(72)	X9 terminal function	[1]	P07	163(A3)	Motor 1 (%R1)	[5]
E10	115(73)	Acceleration time 2	[10]	P08	164(A4)	Motor 1 (%X)	[5]
E11	116(74)	Deceleration time 2	[10]	P09	165(A5)	Motor 1 (Slip compensation control)	[5]
E12	117(75)	Acceleration time 3	[10]	H03	166(A6)	Data initializing	[1] *2
E13	118(76)	Deceleration time 3	[10]	H04	167(A7)	Auto-reset (Times)	[1]
E14	119(77)	Acceleration time 4	[10]	H05	168(A8)	Auto-reset(Reset interval)	[1]
E15	120(78)	Deceleration time 4	[10]	H06	169(A9)	Fan stop operation	[1]
E16	121(79)	Torque limiter 1 (Driving)	[1]	H07	170(AA)	ACC/DCC pattern (Mode selection)	[1]
E17	122(7A)	Torque limiter 1 (Braking)	[1]	H08	171(AB)	Reverse phase sequence lock	[1]
E20	123(7B)	Y1 terminal function	[1]	H09	172(AC)	Start mode (Pick-up mode)	[1]
E21	124(7C)	Y2 terminal function	[1]	H10	173(AD)	Energy-saving operation	[1]
E22	125(7D)	Y3 terminal function	[1]	H11	174(AE)	Deceleration mode	[1]
E23	126(7E)	Y4 terminal function	[1]	H12	175(AF)	Instantaneous overcurrent limiting	[1]
E24	127(7F)	Y5A, Y5C terminal functions	[1]	H13	176(B0)	Auto-restart (Restart time)	[3]
				H14	177(B1)	Auto-restart (Frequency fall rate)	[5]
E30	128(80)	Frequency arrival (FAR) (Detecting width)	[3]	H15	178(B2)	Auto-restart (Holding DC voltage)	[1]
E31	129(81)	Frequency detection 1 (FDT) (level)	[1]	H16	179(B3)	Auto-restart (OPR command selfhold time)	[3] *3
E32	130(82)	Frequency detection (FDT) (Hysteresis width)	[3]	H18	180(B4)	Torque control (Mode selection)	[1]
E33	131(83)	Overload early warning (Mode selection)	[1]	H19	181(B5)	Active drive	[1]
				H20	182(B6)	PID control (Mode selection)	[1]
E34	132(84)	Overload early warning 1 (level)	[10]	H21	183(B7)	PID control (Feed back signal)	[1]
				H22	184(B8)	PID control (P-Gain)	[5]
E35	133(85)	Overload early warning (Timer time)	[3]	H23	185(B9)	PID control (I-time)	[3]
E36	134(86)	Frequency detection 2 (FDT) (level)	[1]	H24	186(BA)	PID control (D-time)	[5]
				H25	187(BB)	PID control (Feedback filter)	[3]

*1) 0.75 kHz is treated as 0000H

*2) The communication might not be able to be continued by writing (data 1).

*3) 999 is treated as 03E7H (99.9).

*4) It is impossible to execute the Auto-tuning via Profibus-DP.

Code	Communication No. decimal (Hex.)	Name	Data Format	Code	Communication No. decimal (Hex.)	Name	Data Format
H26	188(BC)	PTC thermistor (Mode selection)	[1]	o36	235(EB)	Bus Configuration Parameter 07	[1]
H27	189(BD)	PTC thermistor (Level)	[5]	o37	236(EC)	Bus Configuration Parameter 08	[1]
H28	190(BE)	Droop operation	[4]	o38	237(ED)	Bus Configuration Parameter 09	[1]
H30	191(BF)	Serial link (Function selection)	[1]	o39	238(EE)	Bus Configuration Parameter 10	[1]
H31	192(C0)	RS485 (Address)	[1] *1	o40	239(EF)	Bus Configuration Parameter 11	[1]
H32	193(C1)	RS485 (Mode selection on error)	[1] *1	o41/	240(F0)	Bus Configuration Parameter 12/ Base side number of encoder pulses	[1] /
H33	194(C2)	RS485 (Timer time)	[3] *1	(o09)			[1]
H34	195(C3)	RS485 (Baud rate)	[1] *1	o42/	241(F1)	Bus Configuration Parameter 13/ Time constant of pulse train input filter	[1] /
H35	196(C4)	RS485 (Data length)	[1] *1	(o10)			[7]
H36	197(C5)	RS485 (Parity check)	[1] *1	o43/	242(F2)	Bus Configuration Parameter 14/ Command pulse compensation coefficient 1	[1] /
H37	198(C6)	RS485 (Stop bits)	[1] *1	(o11)			[1]
H38	199(C7)	RS485 (No response detection time)	[1] *1	o44/	243(F3)	Bus Configuration Parameter 15/ Command pulse compensation coefficient 2	[1] /
H39	200(C8)	RS485 (Response interval)	[5] *1	(o12)			[1]
A01	201(C9)	Maximum frequency 2	[1]	o45/	244(F4)	Bus Configuration Parameter 16/ Main speed regulator gain	[1] /
A02	202(CA)	Base frequency 2	[1]	(o13)			[3]
A03	203(CB)	Rated voltage 2 (at base speed)	[1]	o46/	245(F5)	Bus Configuration Parameter 17/ APR P gain	[1] /
A04	204(CC)	Maximum output voltage 2	[1]	(o14)			[5]
A05	205(CD)	Torque boost 2	[3]	o47/	246(F6)	Bus Configuration Parameter 18/ Z phase matching gain	[1] /
A06	206(CE)	Electronics thermal 2 (Selection)	[1]	(o15)			[3]
A07	207(CF)	Electronics thermal 2 (Level)	[10]	o48/	247(F7)	Bus Configuration Parameter 19/ Offset angle	[1] /
A08	208(D0)	Electronics thermal 2 (Thermal time constant)	[3]	(o16)			[1]
A09	209(D1)	Torque vector control 2	[1]	o49/	248(F8)	Bus Configuration Parameter 20/ Detecting angle width for completion of synchronizing	[1] /
A10	210(D2)	Motor 2 (Number of motor-2 poles)	[1]	(o17)			[1]
A11	211(D3)	Motor 2 (Capacity)	[5]	o50/	249(F9)	Bus Configuration Parameter 21/ Too mach deviation	[1] /
A12	212(D4)	Motor 2 (Rated current)	[10]	(o18)			[1]
A13	213(D5)	Motor 2 (Auto-tuning)	*2	o51	250(FA)	Bus Configuration Parameter 22/	[1]
A14	214(D6)	Motor 2 (On-line tuning)	[1]	o52	251(FB)	Bus Configuration Parameter 23/	[1]

A15	215(D7)	Motor 2 (No load current	[10]	o53	252(FC)	Bus Configuration Parameter 24/	[1]
A16	216(D8)	Motor 2 (%R1 setting)	[5]	o54	253(FD)	Bus Configuration Parameter 25/	[1]
A17	217(D9)	Motor 2 (%X setting)	[5]	o55	254(FE)	Bus Configuration Parameter 26/	[1]
A18	218(DA)	Motor 2 (Slip compensation control 2)	[5]	-	255(FF)	-	-
o01	219(DB)	Speed command system / automatic speed control system	[15]				
o02	220(DC)	Time constant of PG vector and speed command filter	[7]				
o03	221(DD)	Number of feedback PG pulses	[1]				
o04	222(DE)	Constant P of feedback speed controller	[5]				
o05	223(DF)	Constant I of feedback speed controller	[7]				
o06	224(E0)	Time constant of feedback speed detection filter	[7]				
o07	225(E1)	Feedback pulse correction coefficient 1	[1]				
o08	226(E2)	Feedback pulse correction coefficient 2	[1]				
o27	227(E3)	Mode selection on error	[1]				
o28	228(E4)	Timer time setting	[3]				
o30	229(E5)	Bus Configuration Parameter 01	[1]				
o31	230(E6)	Bus Configuration Parameter 02	[1]				
o32	231(E7)	Bus Configuration Parameter 03	[1]				
o33	232(E8)	Bus Configuration Parameter 04	[1]				
o34	233(E9)	Bus Configuration Parameter 05	[1]				
o35	234(EA)	Bus Configuration Parameter 06	[1]				

*1) Read-only from communication.

*2) It is impossible to execute the Auto-tuning via Profibus-DP.

9.2 Data format specification

All data within the data field of the communication frame consist of 16 bits binary data.

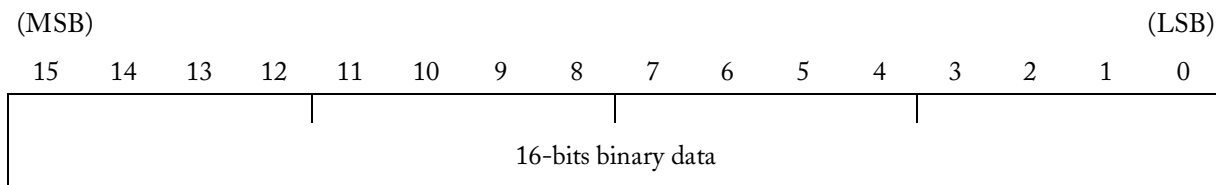

(Negative data is treated with two's complement.)

Data format [1] Integer data (Positive): Min. unit 1

Example) If F15 (Frequency limiter, high limit) = 60 Hz,

$$60 * 1 = 60 = 003C_H$$

->

0	0	3	C
---	---	---	---

Data format [2] Integer data (Positive, negative): Min. unit 1

Example) If F18 (Bias frequency) = -20 Hz,

$$-20 * 1 = -20 = FFEC_H(\text{two's complement})$$

->

F	F	E	C
---	---	---	---

Data format [3] Decimal data (Positive): Min. unit 0.1

Example) If F17 Gain (for frequency setting signal) = 100.0%,

$$100.0 * 10 = 1000 = 03E8_H$$

->

0	3	E	8
---	---	---	---

Data format [4] Decimal data (Positive, negative): Min. unit 0.1

Example) If H28 (Droop operation) = -5.0Hz,

$$-5.0 * 10 = -50 = FFCE_H(\text{two's complement})$$

->

F	F	C	E
---	---	---	---

Data format [5] Decimal data (Positive): Min. unit 0.01

Example) If C05 (Multi-step frequency 1) = 50.25 Hz,

$$50.25 * 100 = 5025 = 13A1_H$$

->

1	3	A	1
---	---	---	---

Data format [6] Decimal data (Positive, negative): Min. unit 0.01

Example) If M07 (Actual torque value) = -85.38%,

$$-85.38 * 100 = -8538 = DEA6_H(\text{two's complement})$$

->

D	E	A	6
---	---	---	---

Data format [7] Decimal data (Positive): Min. unit 0.001

Example) If 0.105 (Constant I of feedback speed controller) = 0.105s,

$$0.105 * 1000 = 105 = 0069_H$$

->

0	0	6	9
---	---	---	---

Data format [8] Decimal data (Positive, negative): Min. unit 0.001

Example) If being -1.234,

$$-1.234 * 1000 = -1234 = FB2E_H(\text{two's complement})$$

->

F	B	2	E
---	---	---	---

Data format [9] Capacity code

Code	Capacity (kW)	Code	Capacity (kW)	Code	Capacity (kW)
5	0.05	1100	11	11000	110
10	0.1	1500	15	13200	132
20	0.2	1850	18.5	16000	160
40	0.4	2200	22	20000	200
75	0.75	3000	30	22000	220
150	1.5	3700	37	25000	250
220	2.2	4500	45	28000	280
370	3.7	5500	55	31500	315
550	5.5	7500	75	35500	355
750	7.5	9000	90	40000	400

Example) If 30kW

$$\text{Since } 30 * 100 = 3000 = 0BB8_H$$

->

0	B	B	8
---	---	---	---

Data format [10] Exponential data (ACC/DEC time, current value, display coefficient)

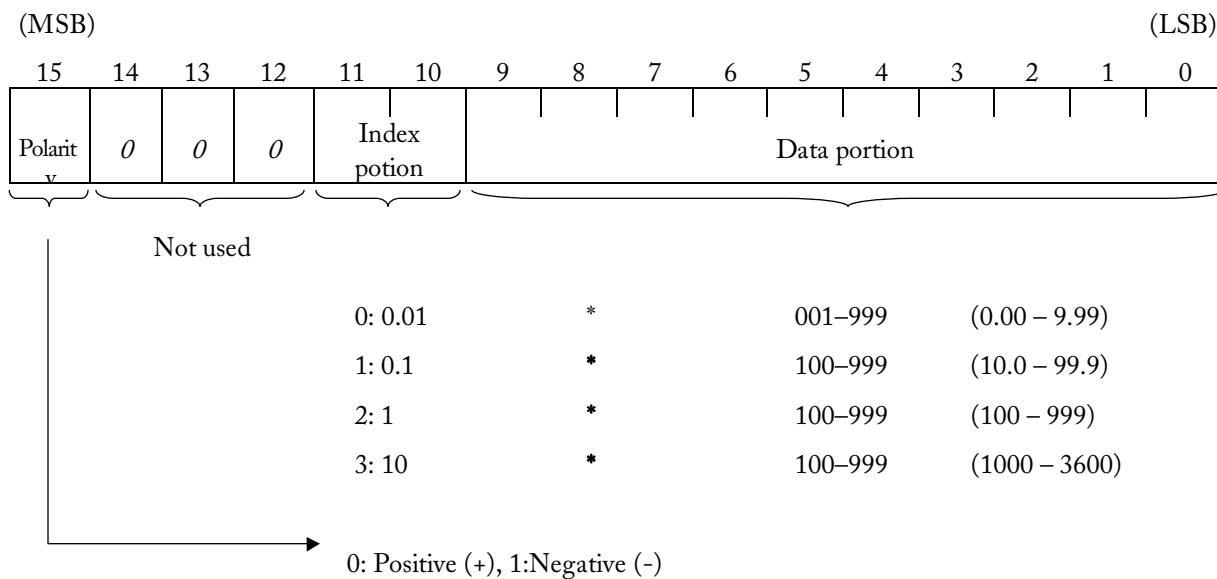

Example) F07 (Acceleration time 1) = 20.0 s,

$$20.0 = 0.1 * 200$$

->

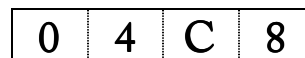

Data format [11] Operation command

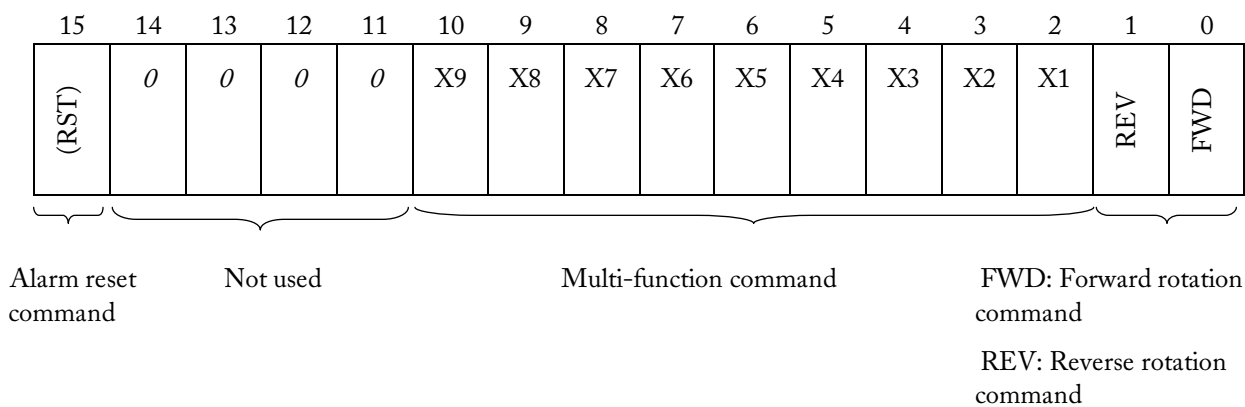

(All bits are ON by 1)

Example) If M13 (Operation command, Final command) = FWD, X1, X5 = ON,

$$0000\ 0000\ 0100\ 0101_b = 0045_H$$

->

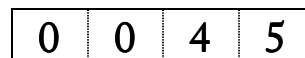

Data format [12] Universal output terminal

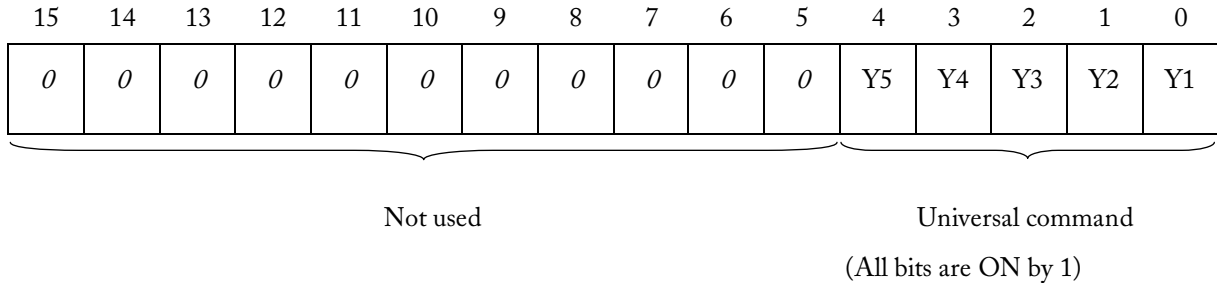

Example) If M15 (Universal output terminal) = Y1, Y5 = ON,

0000 0000 0001 0001_b, = 0011_H

->

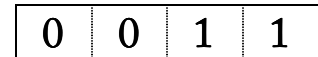

Data format [13] Operating status

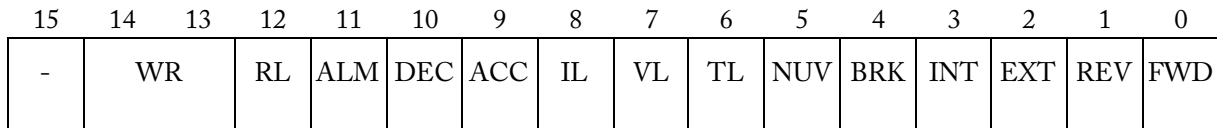

(All bit are ON or active by 1)

- | | |
|---|--|
| <p>FWD: In forward operation</p> <p>REV: In reverse operation</p> <p>EXT: In DC braking (or in pre-excitation)</p> <p>INT: Inverter trip</p> <p>BRK: In braking</p> <p>NUV: DC link voltage is establishment (Undervoltage condition at 0)</p> <p>TL: In torque limiting</p> <p>VL: In voltage limiting</p> | <p>IL: In current limiting</p> <p>ACC: In acceleration</p> <p>DEC: In deceleration</p> <p>ALM: Alarm</p> <p>RL: Transmission valid</p> <p>WR: Function writing right</p> <p style="margin-left: 20px;">0: Keypad panel</p> <p style="margin-left: 20px;">1: RS485</p> <p style="margin-left: 20px;">2: Link (option)</p> |
|---|--|

Example) Omitted (Monitoring method is similar as in the formats [11] and [12].)

Data format [14] Type code

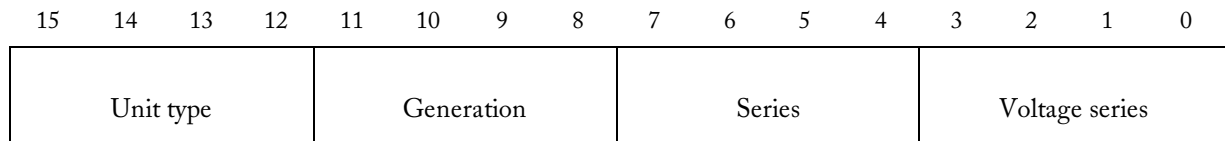

Code	Type	Generation	Series	Voltage series
1	VG	11th series	For Japan	100V single phase
2	G	-	For Asia	200V single phase
3	P	-	For China	200V three phase
4	E	-	For Europe	400V three phase
5	C	-	For USA	575V three phase
6	S	-	-	-

Data format [15] Code setting (1 – 4 figures)

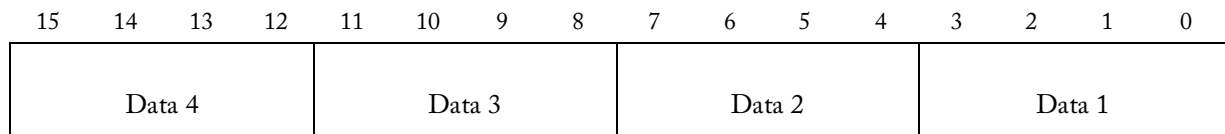

Example) If "o22: Ai function selection" = 123,

Since $123 = 0123_H$

⇒

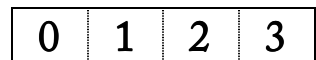

10. System configuration

This is an example on how to configure the SOPC-G11S-PDP in the Siemens Step7 program. In order to enable data exchange between the Step 7 and the Safronics drive two important steps has to be made, the hardware configuration and the correct PLC programming.

10.1 Hardware configuration:

Start up the HW Config program and install the GSD file for the SOPC-G11S-PDP. This is done *under Options/ Install New DDB files*.

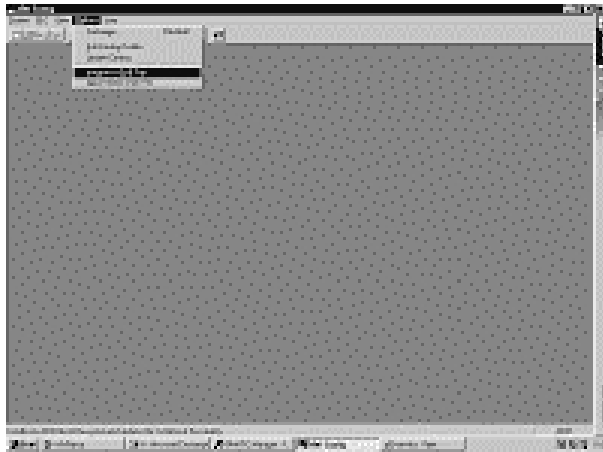

Choose the GSD file HMS_1011 and press open.

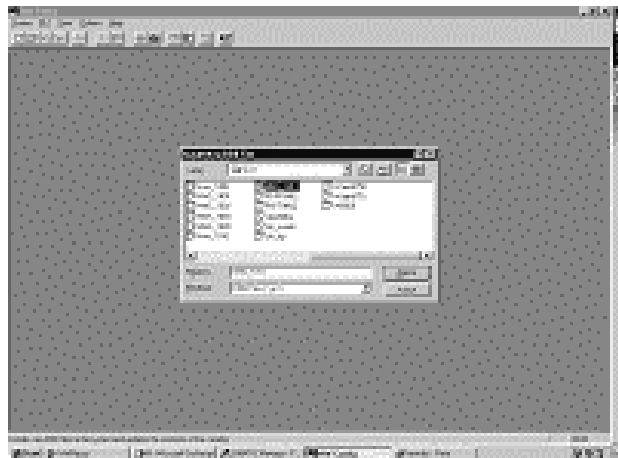

Then start up a new project and configure the PLC and Profibus master. Set-up the Profibus master with baud rate and parameters.

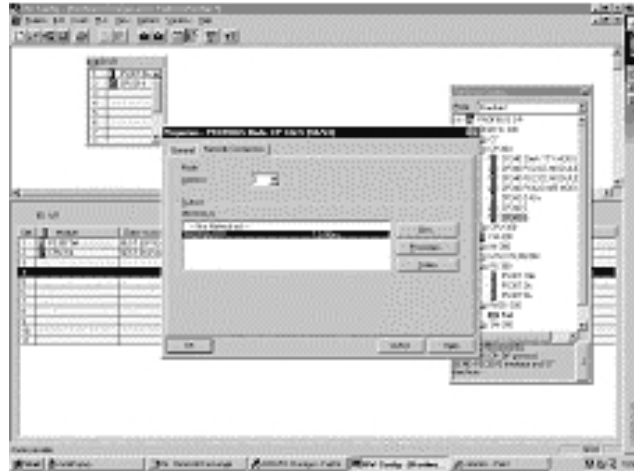

Create a network for the Profibus system by choosing *insert/ DP Master System*.

Click on SOPC-G11S-PDP in the Hardware catalogue (*Profibus DP/Additional Field Devices/ Antriebe*) and drag the folder to the Profibus network line. Then choose the PPO type and press OK.

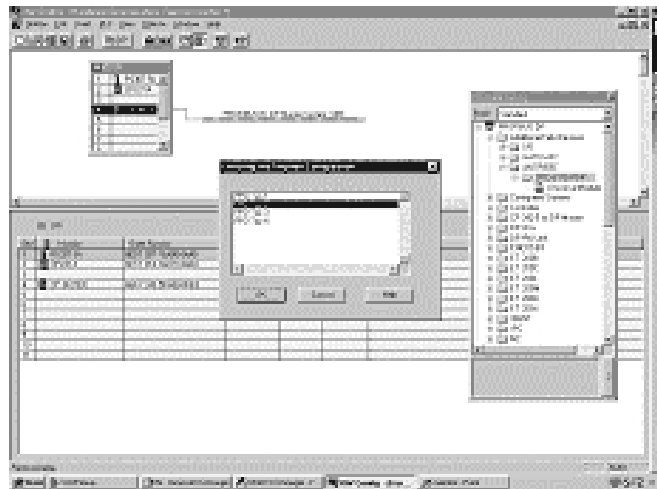

The configuration program will now automatically set-up the module with IN and OUT addresses. To see how the module is configured or to change addresses double click on Universal Module.

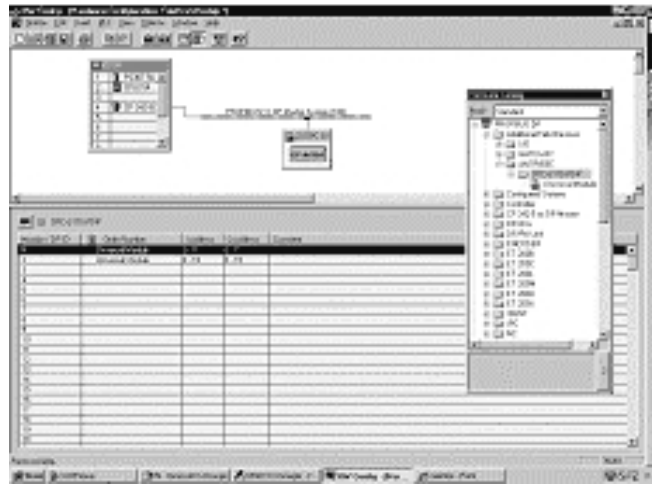

When the module is configured the configuration can be downloaded to the master, this is done under PLC/Download.

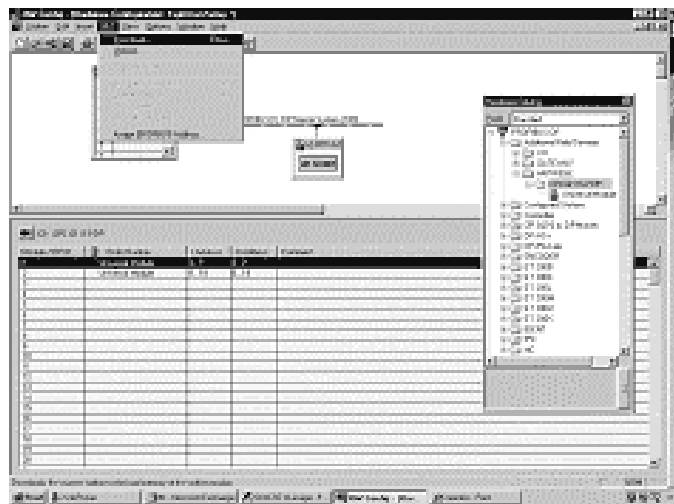

10.2 Software configuration:

This programming example is specific for the Siemens S7 system. It shows how to access data from the drive on Profibus. The actual interpretation of the PCV and PCD part is described in chapter 7 (Operating the drive via the Profidrive Profile). Other systems may not require use of function blocks or the programming must be performed in a different way. Refer to the respective PLC manufacturer to get more information about programming communication.

To enable consistent data transfer the System Function Blocks (SFC:s) SFC14 and SFC15 has to be used in the PLC program. SFC14 and SFC15 are included in the standard Step7 software package, and can be found in the Standard Library or in the PLC. The S7 system will not transport any data if the SFC:s are not used. The SFC:s copies the data between the input /output address area and a user specified memory location. The data can then be read and written by the user program on the user specified memory location.

The use of the SFC:s is dependent on the PPO type used. For PPO 1, 2 and 4 it is necessary to use SFC:s. For PPO 3 SFC:s are not necessary and data can be read/written directly as a double word or two single words. The picture below is a description of this.

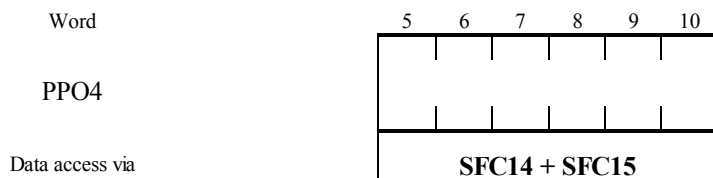
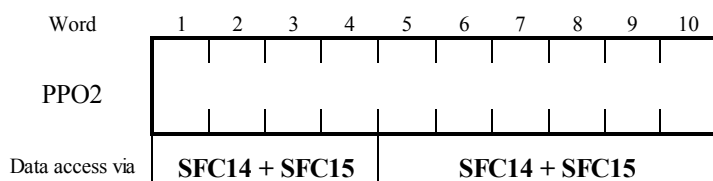
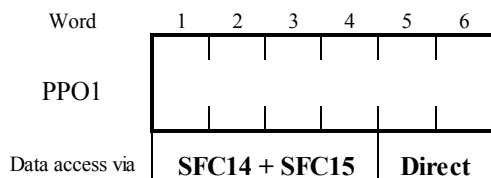
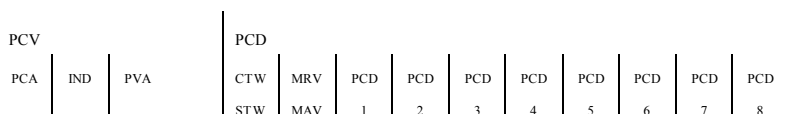

In the example below it is shown how to program the communication if PPO2 is used. The IN0 parameter tells the start address of the input/output area (example: W#16#0). The value should be entered in hex. The RET_VAL is a storage location, word, for error messages from the SFC (example: MW50). The OUT1 and IN1 parameters specifies the user specified storage location and the size of the memory area (example: P#M 0.0 BYTE 8). The start addresses and sizes is according to the values specified in the hardware configuration program HW Config.

In the example below the input PCV-data can be read in MW0 -> MW6 and input PCD-data can be read in MW8 -> MW18. The output PCV-data can be written to MW20 -> MW26 and output PCD-data can be written to MW28 -> MW38. The PCV and PCD part has to be transferred separately because they are configured as separate modules in the hardware configuration program.

The screenshot shows the SIMATIC Manager interface with the following SFC networks:

```

OB1 : Title:
-----
Network 1: Read PCV from drive
CALL SFC 14
  IN0  :=W#16#0
  RET_VAL:=MW50
  OUT1 :=P#M 0.0 BYTE 8

Network 2: Read PCD from drive
CALL SFC 14
  IN0  :=W#16#8
  RET_VAL:=MW54
  OUT1 :=P#M 8.0 BYTE 12

Network 3: Write PCV to drive
CALL SFC 15
  IN0  :=W#16#0
  IN1  :=P#M 20.0 BYTE 8
  RET_VAL:=MW52

Network 4: Write PCD to drive
CALL SFC 15
  IN0  :=W#16#8
  IN1  :=P#M 28.0 BYTE 12
  RET_VAL:=MW56
  
```

File/Block saved. offline Abs Insert

11. GSD-file

Each device on a Profibus-DP network is associated with a GSD file, containing all necessary information about the device. This text file is used by the network configuration program during configuration of the network.

The GSD-file for SOPC-G11S-PDP(HMS_1011.GSD) is shown below.

```
=====
; Profibus Device Database of : HMS Fieldbus Systems DP-slave
; Model : SOPC-G11S-PDP
; Description : Profidrive Profibus-DP option board for Safronics GP10 / VG10 inverter
; Language : English
; Date : 20 October 1999
; Author : HMS Fieldbus Systems AB
=====
#Profibus_DP

GSD_Revision      = 1

; Device identification
Vendor_Name       = "HMS Fieldbus Systems AB"
Model_Name        = "SOPC-G11S-PDP"
Revision          = "Version 1.00"
Ident_Number      = 0x1011
Protocol_Ident    = 0          ; DP protocol
Station_Type      = 0          ; Slave device
FMS_supp          = 0          ; FMS not supported
Hardware_Release  = "Version 1.30"
Software_Release  = "Version 1.00"

; Supported baudrates
9.6_supp          = 1
19.2_supp         = 1
93.75_supp        = 1
187.5_supp        = 1
500_supp          = 1
1.5M_supp         = 1
3M_supp           = 1
6M_supp           = 1
12M_supp          = 1
```

; Maximum responder time for supported baudrates

MaxT_{sdr_9.6} = 60
MaxT_{sdr_19.2} = 60
MaxT_{sdr_93.75} = 60
MaxT_{sdr_187.5} = 60
MaxT_{sdr_500} = 100
MaxT_{sdr_1.5M} = 150
MaxT_{sdr_3M} = 250
MaxT_{sdr_6M} = 450
MaxT_{sdr_12M} = 800

; Supported hardware features

Redundancy = 0 ; not supported
Repeater_Ctrl_Sig = 2 ; TTL
24V_Pins = 0 ; not connected
Implementation_Type = "SPC3"

; Supported DP features

Freeze_Mode_supp = 1 ; supported
Sync_Mode_supp = 1 ; supported
Auto_Baud_supp = 1 ; supported
Set_Slave_Add_supp = 0 ; not supported

; Maximum polling frequency

Min_Slave_Intervall = 1 ; 100 us

; Maximum supported sizes

Modular_Station = 1 ; modular
Max_Module = 1
Max_Input_Len = 20
Max_Output_Len = 20
Max_Data_Len = 40
Modul_Offset = 1

Fail_Safe = 0 ; state CLEAR not accepted

Slave_Family = 1 ; drive

Max_Diag_Data_Len = 6

; Definition of modules

Module = "PPO Typ 1" 0xF3, 0xF1;

EndModule;

Module = "PPO Typ 2" 0xF3, 0xF5;

EndModule;

Module = "PPO Typ 3" 0xF1;

EndModule;

Module = "PPO Typ 4" 0xF5;

EndModule;

